



Ledwide Standard

**LINEAR LED  
PROFILE**

Range 2024-2025



# Ledwide Company Presentation



Company

LEDWIDE Lighting, **established in 2010**, specializes in designs, develops and manufactures custom-made LED lighting for architectural, residential and commercial industries. From concept or enquiry to development and production of all the elements. Our products are based on proprietary aluminum extrusions for strength and cool operation. Our light engines are assembled to customer specifications addressing brightness, color temperature, and efficiency.

We work together with lighting wholesalers, lighting designers, architects to provide the end user with the perfect solution for their applications in **40+ countries**.

### Graphics Department

LEDWIDE Lighting has a graphics design department that designs every single product package, the annual catalogue and website. All product photos are taken in our own photo studio.

### Technical Department

All our products go through all tests required by different lighting standards in order to satisfy the requirements of our international customers. All our products comply with the latest CE, RoHS and EMC standards.

### Our Warehouse

All our products are stored in our 1500m<sup>2</sup> warehouse in Shenzhen. The warehouse has stock of all necessary materials for short deliveries.



Reception



Office



Production



Production

**Will Wang**  
Manage Director



# Profiles Manufacturing



Aluminum Billet



Aluminum Profile Die

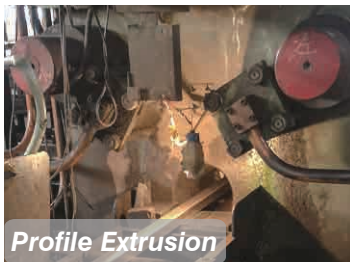

Profile Extrusion



Profile Anodizing



Powder coating

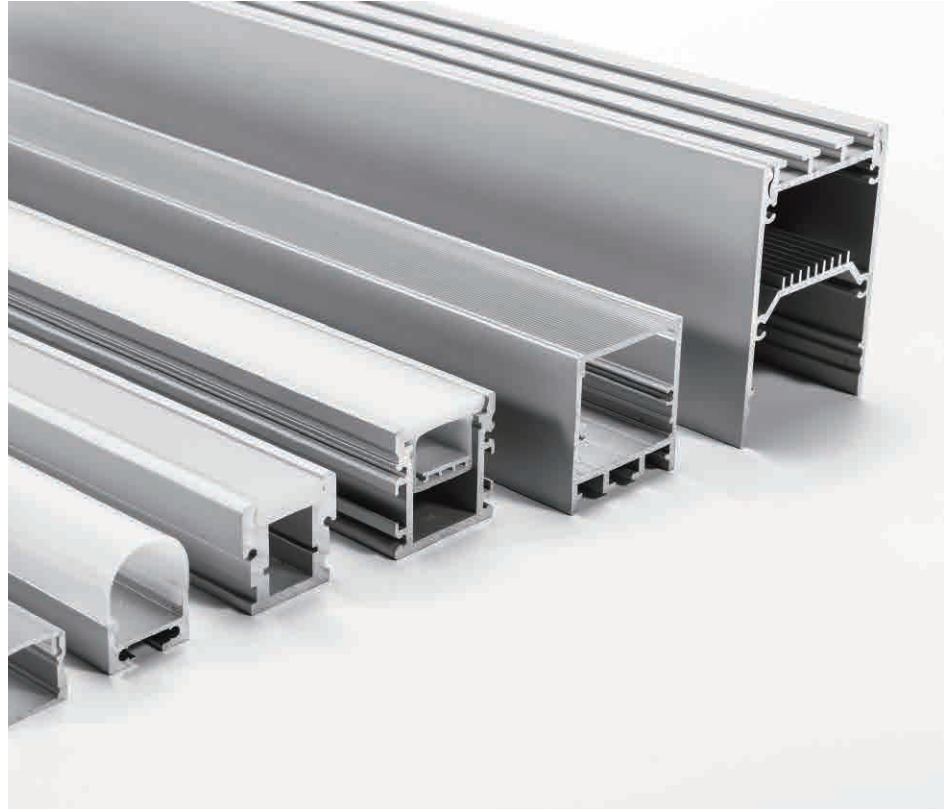

The vast majority of profiles in this catalog have been conceived, **designed by Ledwide and manufactured in Foshan city** (our joint venture factory). For this we have used **an excellent raw material** and have been manufactured under quality standards more demanding and rigorous in **profile dies, extruding, anodized, polishing and powder coating** etc ...

Quality aluminum profile (5 years warranty) with tolerances that are following European Directives: LVD 2014/35/EU, EN 62493:2015; EN 62471:2008. The alloy used is **6063 starting from an aluminum "billet" with a purity between 95-98% and applying a T5 treatment.**

The anodized ones we have made from thickness of 1.2mm to 3.5mm for better heat dissipation, and a **max. length 6000mm.**

# Lens / Diffusers Manufacturing

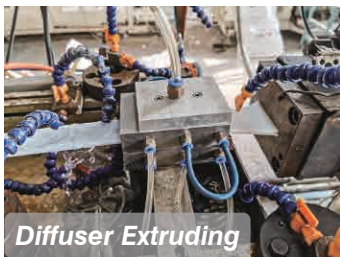

Ledwide using monomer from **Germany Brand "Evonik" UV resistant** PMMA/Acrylic diffusers ( at least 2 years warranty) to suit most of ALU profile extrusions.

PMMA: a material with **high optical performances**, used in applications involving highest transparency and great diffusing properties.

Using LED CONTROL colors, great performances in LED lighting are ensured, like the **invisibility of spots and an excellent transmission-diffusion ration.**

PMMA, which is actually a fragile material, but Ledwide has successfully reinforced with **HIGH-IMPACT resistant material, more flexible** and can be rolled package for easy delivery.

Also for this material, LEDWIDE offers finishes like Opal, Frosted, Milky, Transparent, colored, striped, microprismatic. PMMA is a **UV-resistant material**, so no further protections are required.

Thanks to the blend of different materials diffusion effects are obtained, that result in high transparency, completely **hiding the LED-Spots.**

A great innovation for LED-Lamps satisfying all customer's requests in term of esthetic and functionality, colours, flexibility and innovation.

Ledwide is offering our long term customers following services helps your businesses to take competitive advantage over others.

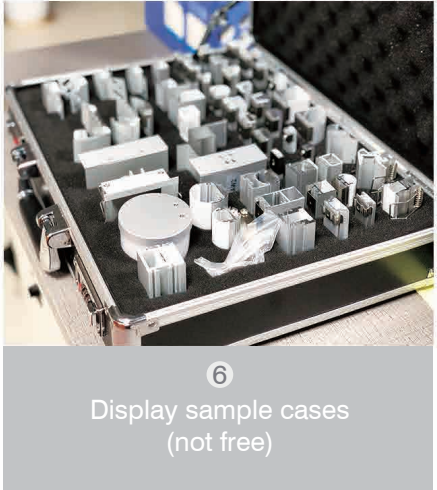
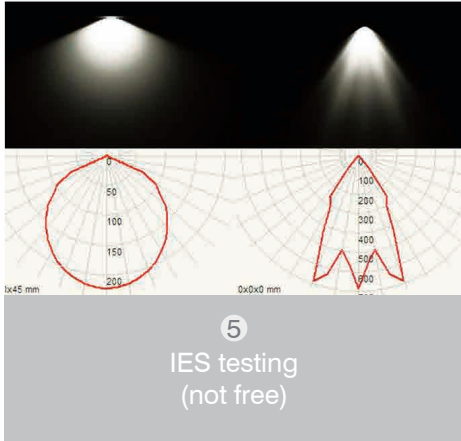
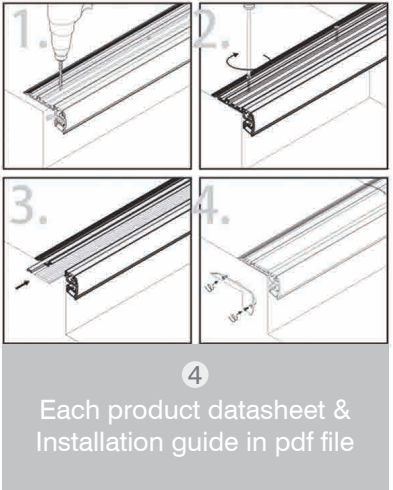
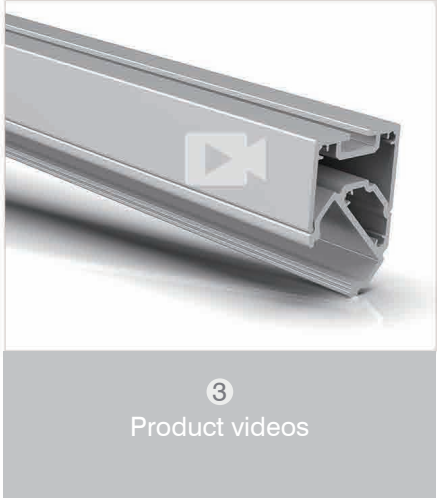
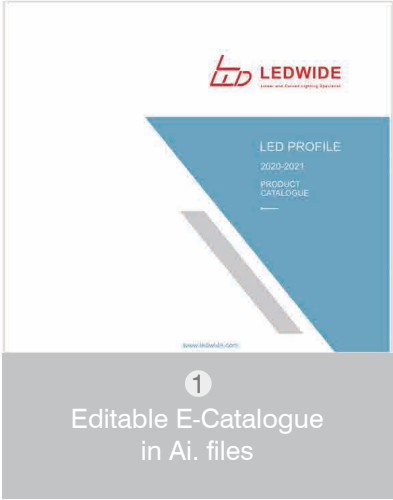

And so on...  
Our company is dedicated to continuous improvement in partnership with our clients.

# Index

## SURFACE



LW-AS9  
page 11



LW-AS5  
page 11



LW-AS1  
page 11



LW-AL60  
page 11



LW-AST1  
page 11



LW-MD  
page 12



LW-AS2  
page 12



LW-B1  
page 12



LW-AS6  
page 12



LW-AS3  
page 12

## RECESSED



LW-AR9  
page 15



LW-AR1  
page 15



LW-AR2  
page 15



LW-AR3  
page 15



LW-ARD1  
page 16



LW-ARD2  
page 16



LW-AR10  
page 16

## ANGLED



LW-AC8N  
page 19



LW-AC1  
page 19



LW-AC2  
page 19



LW-AC3  
page 19



LW-AV2  
page 20

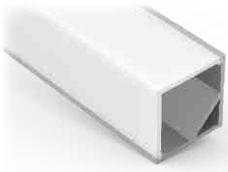

LW-AC4  
page 20

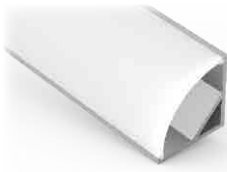

LW-AC5  
page 20



LW-AW7  
page 20

## SURFACE & SUSPENSION



LW-AS1N-H  
page 23



LW-AT11  
page 23



LW-AT4  
page 23



LW-AT5  
page 24



LW-AT6  
page 24



LW-AT16-11  
page 24



LW-AT16-30  
page 25



LW-AT16-60  
page 25



LW-US20  
page 25



LW-U20  
page 26



LW-UST20  
page 26



LW-UST23  
page 26



LW-C25H  
page 27



LW-AT15  
page 27



LW-AT15-30  
page 27



LW-AT15-60  
page 28



LW-AT25-T  
page 28



LW-AT28  
page 28



LW-CS35D  
page 28

## FLOOR & WATERPROOF



LW-AA  
page 31



LW-AB  
page 31



LW-AF1  
page 31



LW-AF2  
page 32



LW-WP3N  
page 32





LW-WP3N-30  
page 32



LW-WP3N-60  
page 33



LW-WP3-T3  
page 33



LW-WP3-T3-30  
page 33



LW-WP3-T3-60  
page 34



LW-AF3  
page 34

### STAIR & STEP



LW-ST2  
page 37



LW-ST1  
page 37



LW-STR3  
page 37

### TUBE & WARDROBE



LW-R24  
page 40



LW-R24-T  
page 40



LW-R30  
page 40



LW-R34  
page 40



LW-R57  
page 40



LW-R60  
page 41



LW-R75  
page 41

### WALL



LW-AW1  
page 43



LW-AW2  
page 43



LW-AW8  
page 43



LW-AW35  
page 44



LW-AW4-1  
page 44

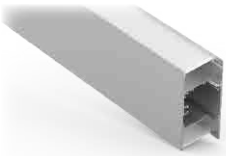

LW-AW5-1  
page 44

### DRIVER BUILT-IN



LW-P35  
page 47



LW-P46  
page 47



LW-P50N  
page 48



LW-P60  
page 48



LW-P50N-S  
page 49



LW-P74  
page 49



LW-P50N-B  
page 50



LW-P74N  
page 50



LW-HG87  
page 51

### TRIMLESS-ARCHITECTURAL



LW-TR35N  
page 53



LW-TR35N-S1  
page 53

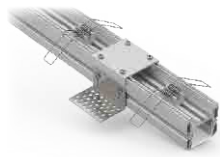

LW-TR35  
page 53

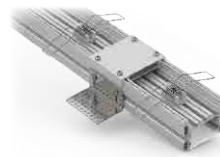

LW-TR50  
page 54



LW-TR60  
page 54



LW-TR80  
page 54

### SURFACE & SUSPENDED-ARCHITECTURAL



LW-P24  
page 57



LW-WN35  
page 57



LW-WN35-25  
page 57



LW-WN35-30  
page 58



LW-WS35  
page 58



LW-E50  
page 58



LW-E60  
page 59



LW-EU60  
page 59



LW-E80  
page 59



LW-EU80  
page 60



LW-W91  
page 60



LW-E100  
page 60

## RECESSED-ARCHITECTURAL



LW-WN31  
page 63



LW-ER50  
page 63



LW-PR50N  
page 63



LW-PR50N-S  
page 64



LW-ER60  
page 64

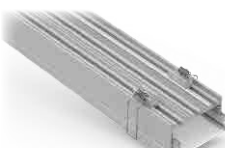

LW-ER80  
page 64

## PLASTER-IN



LW-CT9  
page 67



LW-CT5S  
page 67



LW-CT5  
page 67



LW-CT6  
page 67



LW-CT7  
page 67



LW-CT4N  
page 68



LW-AT7N-1  
page 68



LW-AT10  
page 68



LW-CTD1  
page 68



LW-CTV1  
page 69



LW-CTV2  
page 69

## COVE FRAME SYSTEM



LW-KN1  
page 72

# SURFACE

Page 10 - 11

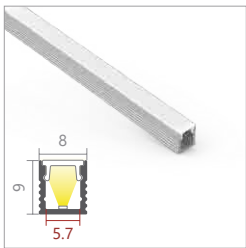
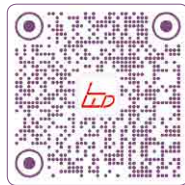

LW-AS9

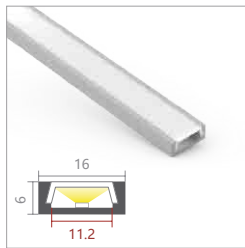

LW-AS5

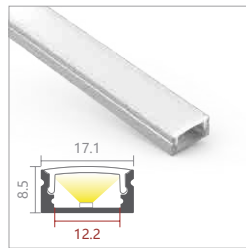

LW-AS1

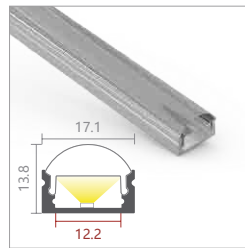

LW-AL60

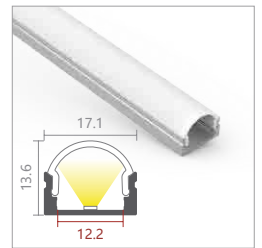

LW-AST1

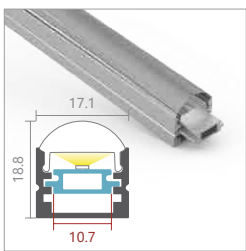

LW-MD

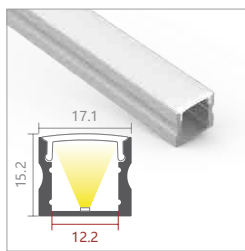

LW-AS2

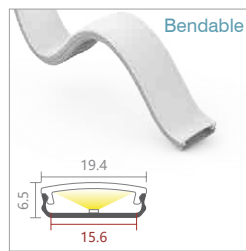

LW-B1

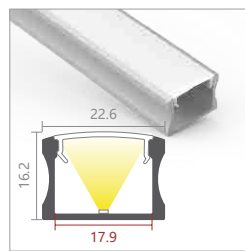

LW-AS6

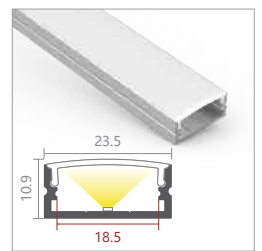

LW-AS3

**LW-AS9**



50°

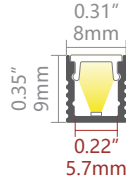

**PC Diffuser**

Code: AS9-O (Opal, light trans. > 45%)



(can be 25m/roll)

**PMMA Diffuser**

Code: AS9-B (Black, light trans. > 24%)

**Accessories**



**Plastic endcap**  
Code: AS9-CAP  
Code: AS9-CAP-H



**Metal clip**  
Code: AS9-CLIP-M

**LW-AS5**



100°

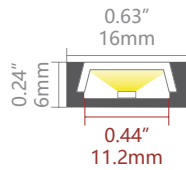

**PC Diffuser**

Code: D002-O (Opal, light trans. > 72%)  
Code: D002-F (Frost, light trans. > 79%)  
Code: D002-C (Clear, light trans. > 97%)



(can be 25m/roll)

**Accessories**



**Plastic endcap**  
Code: AS5-CAP  
Code: AS5-CAP-H



**Metal clip**  
Code: AS4-CLIP-M

**LW-AS1**



100°

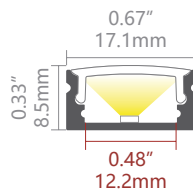

**PMMA Diffuser**

Code: D001-O (Opal, light trans. > 58%)  
Code: D001-M (Milky, light trans. > 75%)  
Code: D001-F (Frost, light trans. > 88%)  
Code: D001-C (Clear, light trans. > 97%)  
Code: D001-B (Black, light trans. > 21%)



(can be 25m/roll)

**Accessories**



**Plastic endcap**  
Code: AS1-CAP  
Code: AS1-CAP-H



**Metal clip**  
Code: AS1-CLIP-M



**Plastic clip**  
Code: AS1-CLIP-P  
(optional)



**Adjustable clip**  
Code: AS1-CLIP-A  
(optional)

**LW-AL60**



60°

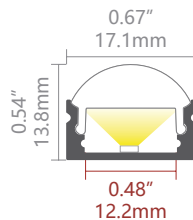

**PC Diffuser**

Code: D004-S-C (Semi-clear, light trans. > 80%)

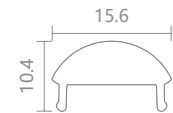

**Accessories**



**Plastic endcap**  
Code: AL60-CAP  
Code: AL60-CAP-H



**Metal clip**  
Code: AS1-CLIP-M



**Plastic clip**  
Code: AS1-CLIP-P  
(optional)



**Adjustable clip**  
Code: AS1-CLIP-A  
(optional)

**LW-AST1**



100°

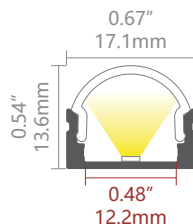

**PMMA Diffuser**

Code: D009-M (Milky, light trans. > 60%)  
Code: D009-C (Clear, light trans. > 95%)

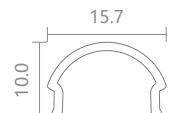

**Accessories**



**Plastic endcap**  
Code: AL60-CAP  
Code: AL60-CAP-H



**Metal clip**  
Code: AS1-CLIP-M



**Plastic clip**  
Code: AS1-CLIP-P  
(optional)



**Adjustable clip**  
Code: AS1-CLIP-A  
(optional)

**LW-MD**

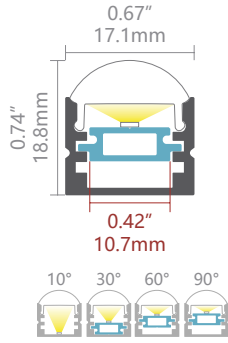

**PC Diffuser**

Code: D004-S-C (Semi-clear, light trans. > 80%)

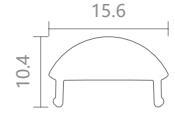

**Accessories**



**LW-AS2**

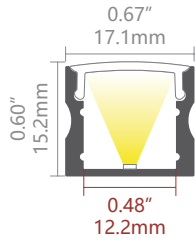

**PMMA Diffuser**

Code: D001-O (Opal, light trans. > 58%)  
 Code: D001-M (Milky, light trans. > 75%)  
 Code: D001-F (Frost, light trans. > 88%)  
 Code: D001-C (Clear, light trans. > 97%)  
 Code: D001-B (Black, light trans. > 21%)

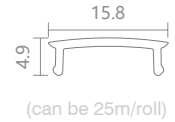

**Accessories**



**LW-B1** Bendable

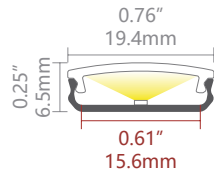

**PMMA Diffuser**

Code: AT11-O (Opal, light trans. > 69%)  
 Code: AT11-F (Frost, light trans. > 83%)  
 Code: AT11-C (Clear, light trans. > 89%)

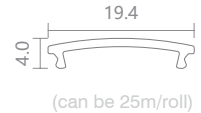

**Accessories**

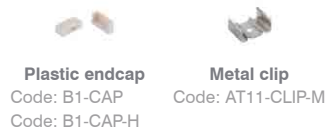

**LW-AS6**

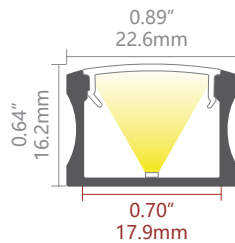

**PMMA Diffuser**

Code: AS6-O (Opal, light trans. > 60%)  
 Code: AS6-F (Frost, light trans. > 86%)  
 Code: AS6-B (Black, light trans. > 26%)

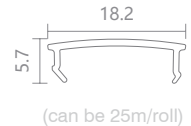

**Accessories**

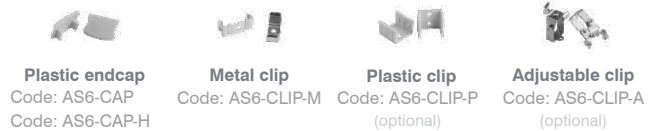

**LW-AS3**

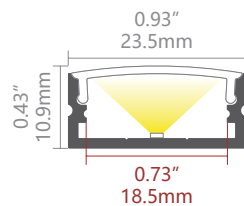

**PMMA Diffuser**

Code: D003-O (Opal, light trans. > 70%)  
 Code: D003-M (Milky, light trans. > 78%)  
 Code: D003-F (Frost, light trans. > 91%)  
 Code: D003-C (Clear, light trans. > 94%)  
 Code: D003-B (Black, light trans. > 20%)

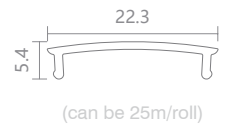

**Accessories**

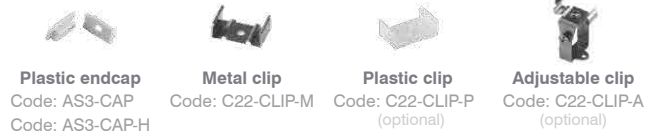

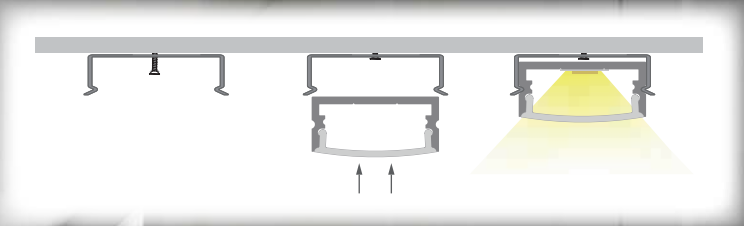

# RECESSED

Page 14 - 17

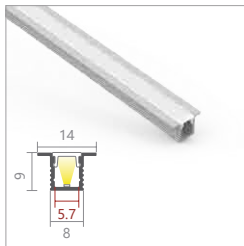
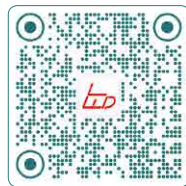

LW-AR9

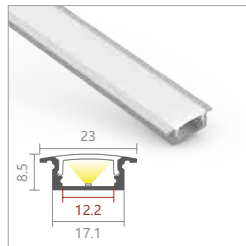

LW-AR1

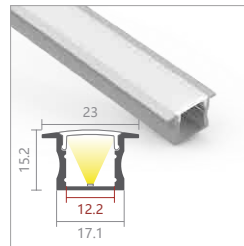

LW-AR2

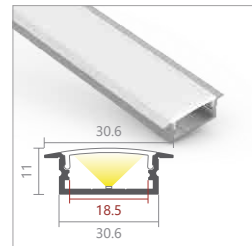

LW-AR3

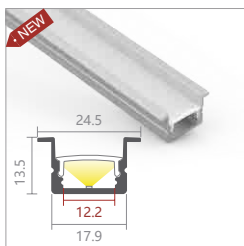

LW-ARD1



LW-ARD2

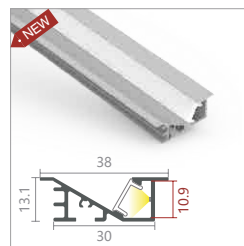

LW-AR10



**LW-AR9**

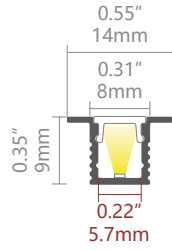

**PC Diffuser**

Code: AS9-O (Opal, light trans. > 45%)

**PMMA Diffuser**

Code: AS9-B (Black, light trans. > 24%)

**Accessories**



**Plastic endcap**  
Code: AR9-CAP  
Code: AR9-CAP-H



**Metal clip**  
Code: AS9-CLIP-M  
(optional)

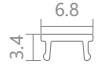

(can be 25m/roll)

**LW-AR1**

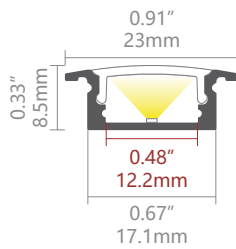

**PMMA Diffuser**

Code: D001-O (Opal, light trans. > 58%)  
Code: D001-M (Milky, light trans. > 75%)  
Code: D001-F (Frost, light trans. > 88%)  
Code: D001-C (Clear, light trans. > 97%)  
Code: D001-B (Black, light trans. > 21%)

**Accessories**



**Plastic endcap**  
Code: AR1-CAP  
Code: AR1-CAP-H



**Metal clip**  
Code: AS1-CLIP-M  
(optional)



**Plastic clip**  
Code: AS1-CLIP-P  
(optional)



(can be 25m/roll)

**LW-AR2**

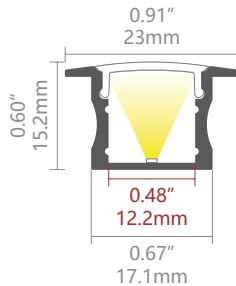

**PMMA Diffuser**

Code: D001-O (Opal, light trans. > 58%)  
Code: D001-M (Milky, light trans. > 75%)  
Code: D001-F (Frost, light trans. > 88%)  
Code: D001-C (Clear, light trans. > 97%)  
Code: D001-B (Black, light trans. > 21%)

**Accessories**



**Plastic endcap**  
Code: AR2-CAP  
Code: AR2-CAP-H



**Metal clip**  
Code: AS1-CLIP-M  
(optional)



**Plastic clip**  
Code: AS1-CLIP-P  
(optional)



(can be 25m/roll)

**LW-AR3**

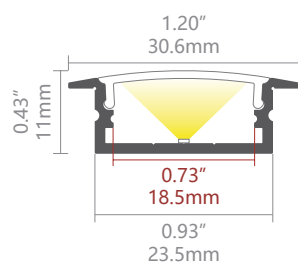

**PMMA Diffuser**

Code: D003-O (Opal, light trans. > 70%)  
Code: D003-M (Milky, light trans. > 78%)  
Code: D003-F (Frost, light trans. > 91%)  
Code: D003-C (Clear, light trans. > 94%)  
Code: D003-B (Black, light trans. > 20%)

**Accessories**



**Plastic endcap**  
Code: AR3-CAP  
Code: AR3-CAP-H



**Metal clip**  
Code: C22-CLIP-M  
(optional)



(can be 25m/roll)

**LW-ARD1** NEW

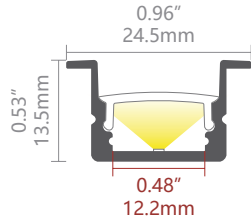

**PMMA Diffuser**

- Code: D001-O (Opal, light trans. > 58%)
- Code: D001-M (Milky, light trans. > 75%)
- Code: D001-F (Frost, light trans. > 88%)
- Code: D001-C (Clear, light trans. > 97%)
- Code: D001-B (Black, light trans. > 21%)

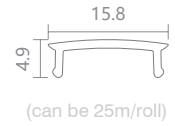

**Accessories**

-   
**Plastic endcap**  
 Code: ARD1-CAP  
 Code: ARD1-CAP-H
-   
**Metal clip**  
 Code: AS1-CLIP-M  
 (optional)
-   
**Plastic clip**  
 Code: AS1-CLIP-P  
 (optional)

**LW-ARD2** NEW

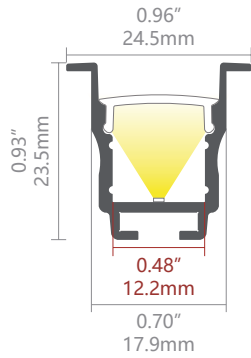



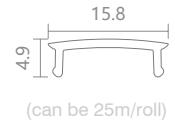

**PMMA Diffuser**

- Code: D001-O (Opal, light trans. > 58%)
- Code: D001-M (Milky, light trans. > 75%)
- Code: D001-F (Frost, light trans. > 88%)
- Code: D001-C (Clear, light trans. > 97%)
- Code: D001-B (Black, light trans. > 21%)



**Accessories**

-   
**CNC Aluminium endcap**  
 Code: ARD2-CAP-N
  -   
**Spring clip**  
 Code: SC-AW6
  -   
**Joiner 90°A**  
 Code: J-90A  
 (optional)
  -   
**Joiner 90°B**  
 Code: J-90B  
 (optional)
- 
-   
**Joiner 180°A**  
 Code: J-180A  
 (optional)

**LW-AR10** NEW

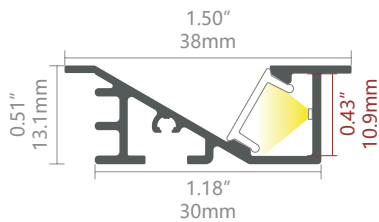

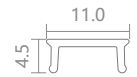

**PMMA Diffuser**

- Code: AR10-O (Opal, light trans. > 65%)



**Accessories**

-   
**Aluminium endcap**  
 Code: AR10-CAP
-   
**Joiner 90°A**  
 Code: J-90A  
 (optional)
-   
**Joiner 180°A**  
 Code: J-180A  
 (optional)
-   
**Spring clip**  
 Code: SC-AW6

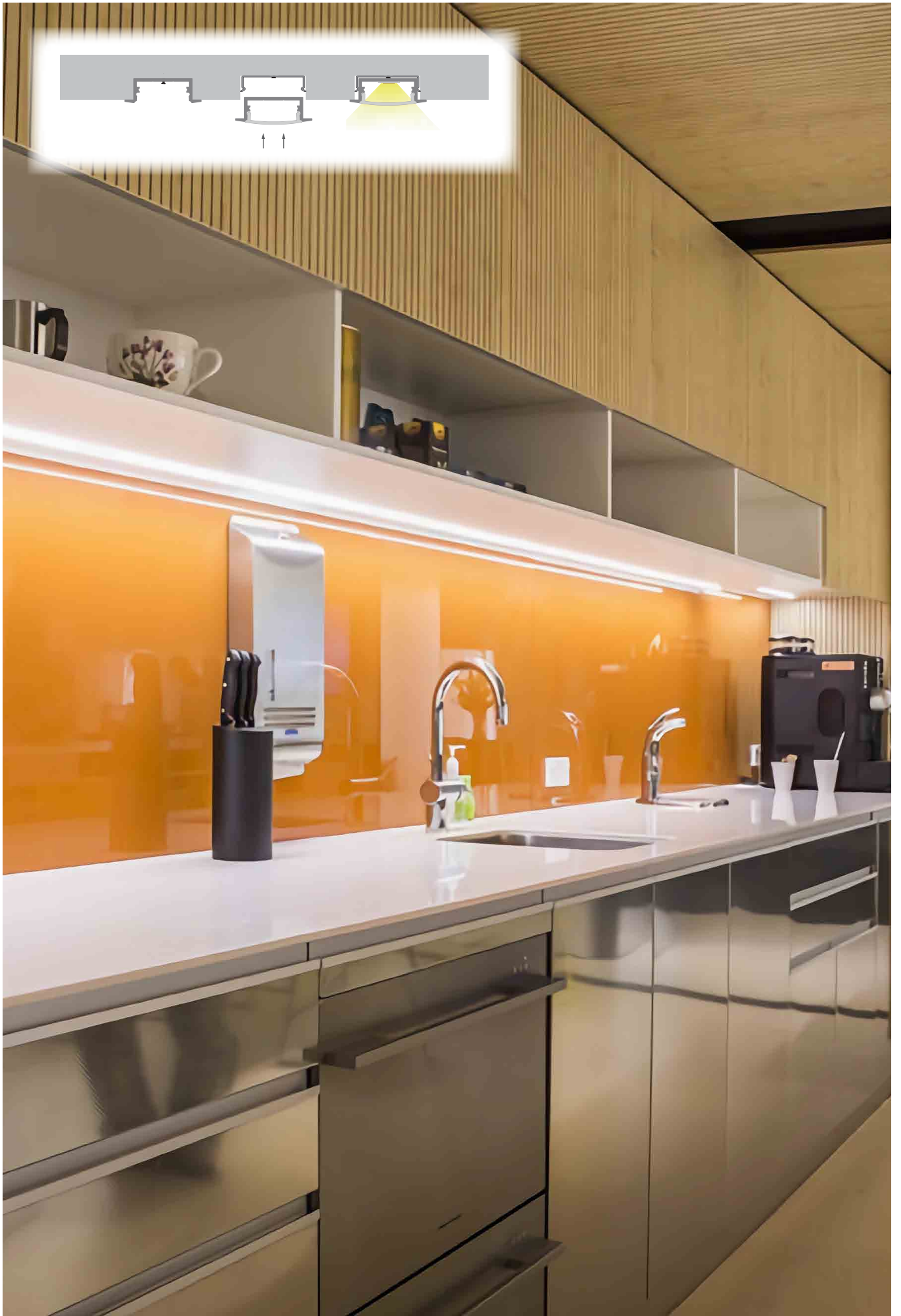

# ANGLED

Page 18 - 21

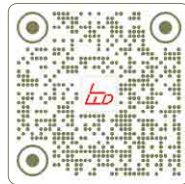

LW-AC8N

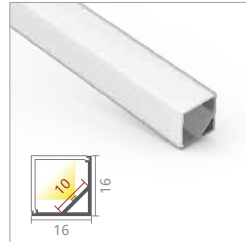

LW-AC1

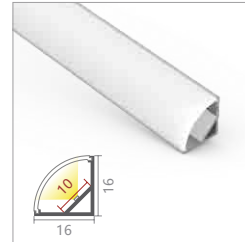

LW-AC2

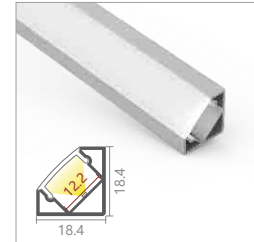

LW-AC3

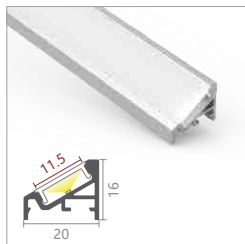

LW-AV2

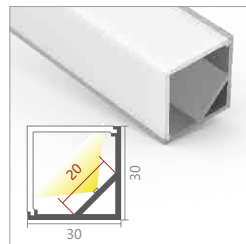

LW-AC4

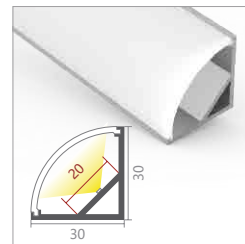

LW-AC5

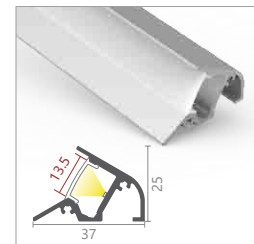

LW-AW7

**LW-AC8N** EXCLUSIVE IN KW NEW

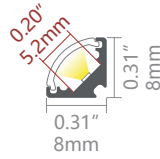

**PC Diffuser**

Code: AC8-O (Opal, light trans. > 70%)



**Accessories**



**Plastic endcap**  
Code: AC8-CAP  
Code: AC8-CAP-H



**Metal clip**  
Code: AC8-CLIP-M

**LW-AC1**

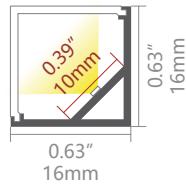

**PMMA Diffuser**

Code: AC1-O (Opal, light trans. > 43%)  
Code: AC1-M (Milky, light trans. > 49%)  
Code: AC1-F (Frost, light trans. > 54%)  
Code: AC1-C (Clear, light trans. > 57%)

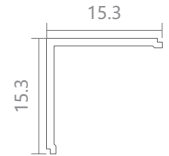

**Accessories**



**Plastic endcap**  
Code: AC1-CAP  
Code: AC1-CAP-H



**Metal clip**  
Code: AC1-CLIP-M



**Plastic clip**  
Code: AC1-CLIP-P  
(optional)



**Adjustable clip**  
Code: AC1-CLIP-A  
(optional)

**LW-AC2**

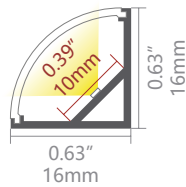

**PMMA Diffuser**

Code: AC2-O (Opal, light trans. > 55%)  
Code: AC2-M (Milky, light trans. > 61%)  
Code: AC2-F (Frost, light trans. > 70%)  
Code: AC2-C (Clear, light trans. > 76%)  
Code: AC2-B (Black, light trans. > 21%)



**Accessories**



**Plastic endcap**  
Code: AC2-CAP  
Code: AC2-CAP-H



**Metal clip**  
Code: AC1-CLIP-M



**Plastic clip**  
Code: AC1-CLIP-P  
(optional)



**Adjustable clip**  
Code: AC1-CLIP-A  
(optional)

**LW-AC3**

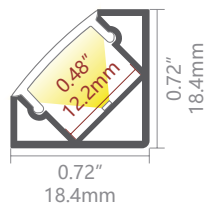

**PMMA Diffuser**

Code: D001-O (Opal, light trans. > 58%)  
Code: D001-M (Milky, light trans. > 75%)  
Code: D001-F (Frost, light trans. > 88%)  
Code: D001-C (Clear, light trans. > 97%)  
Code: D001-B (Black, light trans. > 21%)

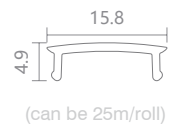

**Accessories**



**Plastic endcap**  
Code: AC3-CAP  
Code: AC3-CAP-H



**Metal clip**  
Code: AC3-CLIP-M



**Plastic clip**  
Code: AC3-CLIP-P  
(optional)



**Adjustable clip**  
Code: AC3-CLIP-A  
(optional)

**LW-AV2**

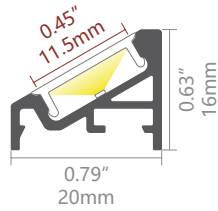



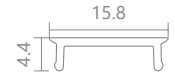

**PMMA Diffuser**

Code: D001-O FLAT (Opal, light trans. > 68%)



(can be 25m/roll)

**Accessories**

 <b>Plastic endcap</b> Code: AV2-CAP-L Code: AV2-CAP-R	 <b>Metal clip</b> Code: US20-CLIP-M	 <b>Joiner 60°B</b> Code: J-60B (optional)	 <b>Joiner 90°A</b> Code: J-90A (optional)
 <b>Joiner 90°B</b> Code: J-90B (optional)	 <b>Joiner 120°A</b> Code: J-120A (optional)	 <b>Joiner 120°B</b> Code: J-120B (optional)	 <b>Joiner 180°A</b> Code: J-180A (optional)

**LW-AC4**

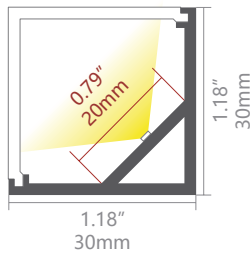
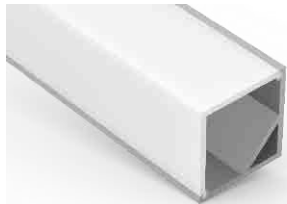



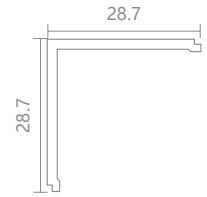

**PC Diffuser**

Code: AC4-O (Opal, light trans. > 41%)  
Code: AC4-F (Frost, light trans. > 43%)  
Code: AC4-C (Clear, light trans. > 50%)



**Accessories**

 <b>Plastic endcap</b> Code: AC4-CAP Code: AC4-CAP-H	 <b>Metal clip</b> Code: AC4-CLIP-M	 <b>Plastic clip</b> Code: AC4-CLIP-P (optional)	 <b>Adjustable clip</b> Code: AC4-CLIP-A (optional)
--	--	--	---

**LW-AC5**

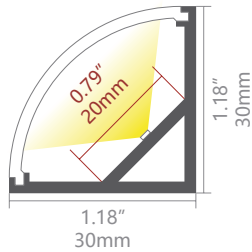
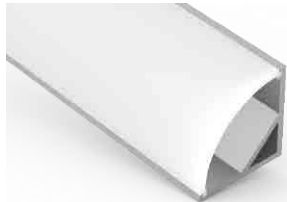



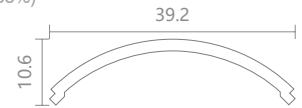

**PC Diffuser**

Code: AC5-O (Opal, light trans. > 51%)  
Code: AC5-F (Frost, light trans. > 53%)  
Code: AC5-C (Clear, light trans. > 66%)



**Accessories**

 <b>Plastic endcap</b> Code: AC5-CAP Code: AC5-CAP-H	 <b>Metal clip</b> Code: AC4-CLIP-M	 <b>Plastic clip</b> Code: AC4-CLIP-P (optional)	 <b>Adjustable clip</b> Code: AC4-CLIP-A (optional)
--	--	--	---

**LW-AW7**

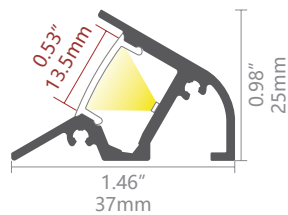

**PMMA Diffuser**

Code: D001-O (Opal, light trans. > 58%)  
Code: D001-M (Milky, light trans. > 75%)  
Code: D001-F (Frost, light trans. > 88%)  
Code: D001-C (Clear, light trans. > 97%)  
Code: D001-B (Black, light trans. > 21%)

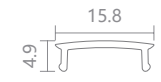

(can be 25m/roll)

**Accessories**

 <b>CNC Aluminium endcap</b> Code: AW7-CAP-L Code: AW7-CAP-R
--



Ceiling Wash Floor Wash Wall Wash

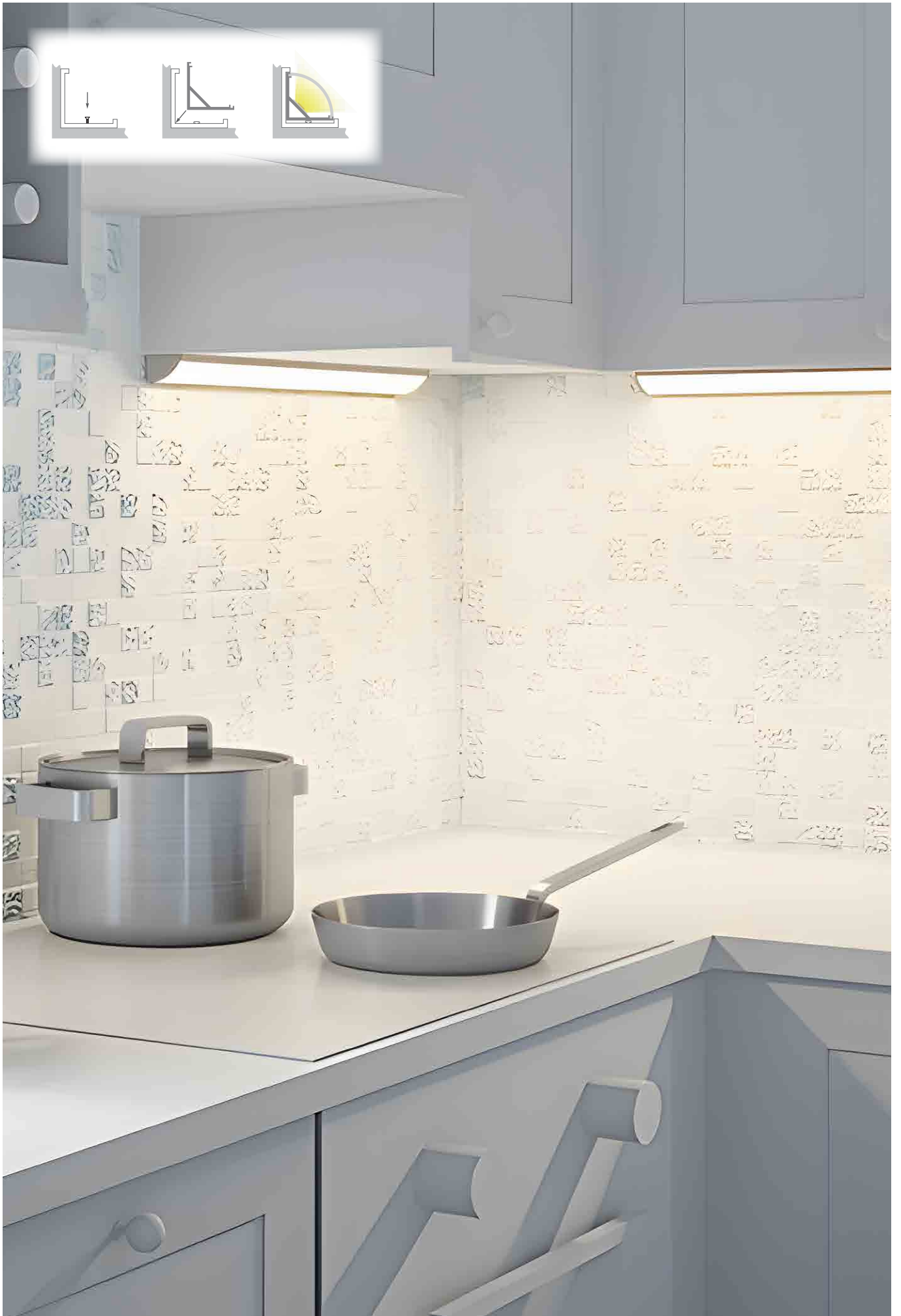

# SURFACE & SUSPENSION

Page 22 - 29

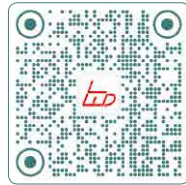

LW-AS1N-H



LW-AT11



LW-AT4



LW-AT5



LW-AT6



LW-AT16-11

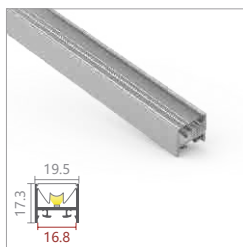

LW-AT16-30

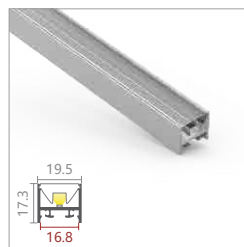

LW-AT16-60



LW-US20

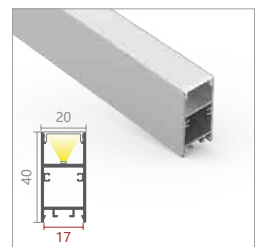

LW-U20



LW-UST20



LW-UST23

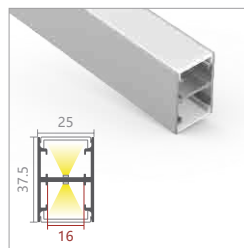

LW-C25H

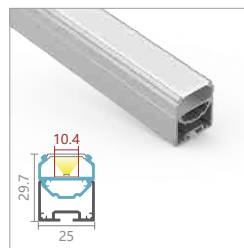

LW-AT15

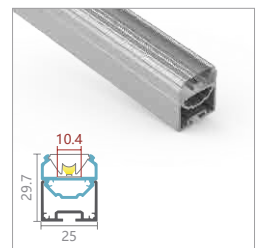

LW-AT15-30

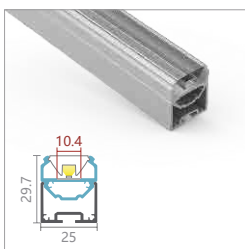

LW-AT15-60



LW-AT25-T

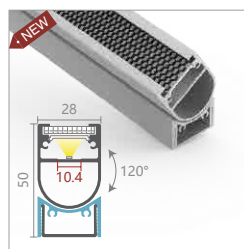

LW-AT28

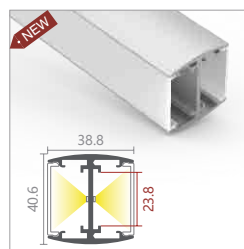

LW-CS35D



## LW-AS1N-H NEW

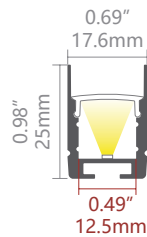

### PMMA Diffuser

- Code: D001-O (Opal, light trans. > 58%)
- Code: D001-M (Milky, light trans. > 75%)
- Code: D001-F (Frost, light trans. > 88%)
- Code: D001-C (Clear, light trans. > 97%)
- Code: D001-B (Black, light trans. > 21%)

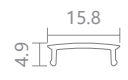

(can be 25m/roll)

### Accessories

- |   |   |  |
|---|---|--|
| <br><b>Plastic endcap</b><br>Code: AS1N-H-CAP<br>Code: AS1N-H-CAP-H | <br><b>Metal clip</b><br>Code: AS1-CLIP-M             | <br><b>Adjustable clip</b><br>Code: AS1-CLIP-A<br>(optional) |
| <br><b>Suspension kits</b><br>Code: Sus.KitsA<br>(optional)         | <br><b>Joiner 90°A</b><br>Code: J-90A<br>(optional)   | <br><b>Joiner 90°B</b><br>Code: J-90B<br>(optional)          |
| <br><b>Joiner 120°A</b><br>Code: J-120A<br>(optional)               | <br><b>Joiner 120°B</b><br>Code: J-120B<br>(optional) | <br><b>Joiner 180°A</b><br>Code: J-180A<br>(optional)        |

## LW-AT11

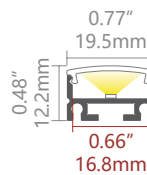

### PMMA Diffuser

- Code: AT11-O (Opal, light trans. > 69%)
- Code: AT11-F (Frost, light trans. > 83%)
- Code: AT11-C (Clear, light trans. > 89%)

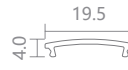

(can be 25m/roll)

### Accessories

- |   |   |   |
|---|---|---|
| <br><b>Aluminium endcap</b><br>Code: AT11-CAP<br>Code: AT11-CAP-H | <br><b>Metal clip</b><br>Code: AT11-CLIP-M            | <br><b>Adjustable clip</b><br>Code: AT11-CLIP-A<br>(optional) |
| <br><b>Suspension kits</b><br>Code: Sus.KitsA<br>(optional)       | <br><b>Joiner 90°A</b><br>Code: J-90A<br>(optional)   | <br><b>Joiner 90°B</b><br>Code: J-90B<br>(optional)           |
| <br><b>Joiner 120°A</b><br>Code: J-120A<br>(optional)             | <br><b>Joiner 120°B</b><br>Code: J-120B<br>(optional) | <br><b>Joiner 180°A</b><br>Code: J-180A<br>(optional)         |

## LW-AT4

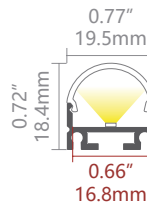

### PMMA Diffuser

- Code: D006-O (Opal, light trans. > 33%)
- Code: D006-F (Frost, light trans. > 61%)
- Code: D006-C (Clear, light trans. > 65%)



(can be 25m/roll)

### Accessories

- |   |   |   |
|---|---|---|
| <br><b>Plastic endcap</b><br>Code: AT4-CAP<br>Code: AT4-CAP-H | <br><b>Metal clip</b><br>Code: AT11-CLIP-M            | <br><b>Adjustable clip</b><br>Code: AT11-CLIP-A<br>(optional) |
| <br><b>Suspension kits</b><br>Code: Sus.KitsA<br>(optional)   | <br><b>Joiner 90°A</b><br>Code: J-90A<br>(optional)   | <br><b>Joiner 90°B</b><br>Code: J-90B<br>(optional)           |
| <br><b>Joiner 120°A</b><br>Code: J-120A<br>(optional)         | <br><b>Joiner 120°B</b><br>Code: J-120B<br>(optional) | <br><b>Joiner 180°A</b><br>Code: J-180A<br>(optional)         |

### LW-AT5

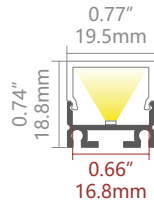

### PMMA Diffuser

- Code: D007-O (Opal, light trans. > 51%)
- Code: D007-M (Milky, light trans. > 56%)
- Code: D007-F (Frost, light trans. > 65%)
- Code: D007-C (Clear, light trans. > 73%)
- Code: D007-B (Black, light trans. > 18%)

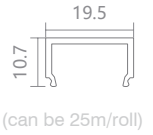

### Accessories

- |   |   |   |
|---|---|---|
|   |   |   |
| <b>Plastic endcap</b><br>Code: AT5-CAP<br>Code: AT5-CAP-H | <b>Metal clip</b><br>Code: AT11-CLIP-M            | <b>Adjustable clip</b><br>Code: AT11-CLIP-A<br>(optional) |
|   |   |   |
| <b>Suspension kits</b><br>Code: Sus.KitsA<br>(optional)   | <b>Joiner 90°A</b><br>Code: J-90A<br>(optional)   | <b>Joiner 90°B</b><br>Code: J-90B<br>(optional)           |
|   |   |   |
| <b>Joiner 120°A</b><br>Code: J-120A<br>(optional)         | <b>Joiner 120°B</b><br>Code: J-120B<br>(optional) | <b>Joiner 180°A</b><br>Code: J-180A<br>(optional)         |

### LW-AT6

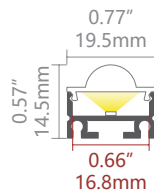

### PMMA Diffuser

- Code: D008-C (Clear, light trans. > 115%)

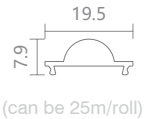

### Accessories

- |   |   |   |
|---|---|---|
|   |   |   |
| <b>Plastic endcap</b><br>Code: AT6-CAP<br>Code: AT6-CAP-H | <b>Metal clip</b><br>Code: AT11-CLIP-M            | <b>Adjustable clip</b><br>Code: AT11-CLIP-A<br>(optional) |
|   |   |   |
| <b>Suspension kits</b><br>Code: Sus.KitsA<br>(optional)   | <b>Joiner 90°A</b><br>Code: J-90A<br>(optional)   | <b>Joiner 90°B</b><br>Code: J-90B<br>(optional)           |
|   |   |   |
| <b>Joiner 120°A</b><br>Code: J-120A<br>(optional)         | <b>Joiner 120°B</b><br>Code: J-120B<br>(optional) | <b>Joiner 180°A</b><br>Code: J-180A<br>(optional)         |

### LW-AT16-11

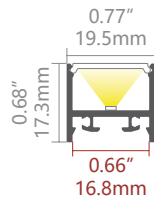

### PMMA Diffuser

- Code: AT15-O (Opal, light trans. > 65%)

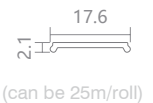

### Accessories

- |   |   |   |
|---|---|---|
|   |   |   |
| <b>Aluminium endcap</b><br>Code: AT16-11-CAP<br>Code: AT16-11-CAP-H | <b>Metal clip</b><br>Code: US20-CLIP-M            | <b>Suspension kits</b><br>Code: Sus.KitsA<br>(optional) |
|   |   |   |
| <b>Joiner 60°B</b><br>Code: J-60B<br>(optional)                     | <b>Joiner 90°A</b><br>Code: J-90A<br>(optional)   | <b>Joiner 90°B</b><br>Code: J-90B<br>(optional)         |
|   |   |   |
| <b>Joiner 120°A</b><br>Code: J-120A<br>(optional)                   | <b>Joiner 120°B</b><br>Code: J-120B<br>(optional) | <b>Joiner 180°A</b><br>Code: J-180A<br>(optional)       |

**LW-AT16-30**

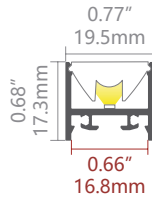

**PMMA Diffuser**

Code: AT12N-C (Clear, light trans. > 133%)



**Accessories**

- |   |   |   |
|---|---|---|
|   |   |   |
| <b>Aluminium endcap</b><br>Code: AT16-11-CAP<br>Code: AT16-11-CAP-H | <b>Metal clip</b><br>Code: US20-CLIP-M            | <b>Suspension kits</b><br>Code: Sus.KitsA<br>(optional) |
|   |   |   |
| <b>Joiner 60°B</b><br>Code: J-60B<br>(optional)                     | <b>Joiner 90°A</b><br>Code: J-90A<br>(optional)   | <b>Joiner 90°B</b><br>Code: J-90B<br>(optional)         |
|   |   |   |
| <b>Joiner 120°A</b><br>Code: J-120A<br>(optional)                   | <b>Joiner 120°B</b><br>Code: J-120B<br>(optional) | <b>Joiner 180°A</b><br>Code: J-180A<br>(optional)       |

**LW-AT16-60**

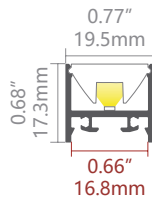

**PMMA Diffuser**

Code: AT12N-C (Clear, light trans. > 133%)



**Accessories**

- |   |   |   |
|---|---|---|
|   |   |   |
| <b>Aluminium endcap</b><br>Code: AT16-11-CAP<br>Code: AT16-11-CAP-H | <b>Metal clip</b><br>Code: US20-CLIP-M            | <b>Suspension kits</b><br>Code: Sus.KitsA<br>(optional) |
|   |   |   |
| <b>Joiner 60°B</b><br>Code: J-60B<br>(optional)                     | <b>Joiner 90°A</b><br>Code: J-90A<br>(optional)   | <b>Joiner 90°B</b><br>Code: J-90B<br>(optional)         |
|   |   |   |
| <b>Joiner 120°A</b><br>Code: J-120A<br>(optional)                   | <b>Joiner 120°B</b><br>Code: J-120B<br>(optional) | <b>Joiner 180°A</b><br>Code: J-180A<br>(optional)       |

**LW-US20**

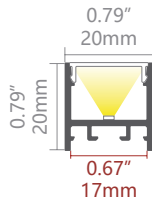

**PMMA Diffuser**

Code: U20-O (Opal, light trans. > 64%)  
Code: U20-B (Black, light trans. > 23%)

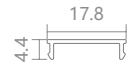

(can be 25m/roll)

**Accessories**

- |  |   |  |   |
|--|---|--|---|
|  |   |  |   |
| <b>Plastic endcap</b><br>Code: US20-CAP<br>Code: US20-CAP-H  | <b>Metal clip</b><br>Code: US20-CLIP-M            | <b>Aluminum diffuser</b><br>Code: U20-AD<br>(optional) | <b>Suspension kits</b><br>Code: Sus.KitsA<br>(optional) |
|  |   |  |   |
| <b>CNC Aluminum endcap</b><br>Code: US20-CAP-N<br>(optional) | <b>Joiner 60°B</b><br>Code: J-60B<br>(optional)   | <b>Joiner 90°A</b><br>Code: J-90A<br>(optional)        | <b>Joiner 90°B</b><br>Code: J-90B<br>(optional)         |
|  |   |  |   |
| <b>Joiner 120°A</b><br>Code: J-120A<br>(optional)            | <b>Joiner 120°B</b><br>Code: J-120B<br>(optional) | <b>Joiner 180°A</b><br>Code: J-180A<br>(optional)      |   |

**LW-U20**

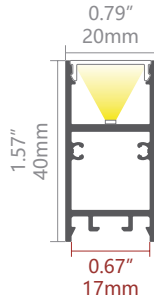
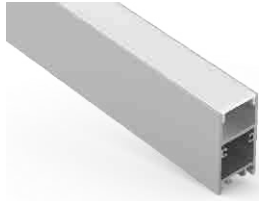

**PMMA Diffuser**

Code: U20-O (Opal, light trans. > 64%)  
 Code: U20-B (Black, light trans. > 23%)

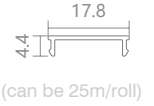

**Accessories**

- |  |  |   |   |
|--|--|---|---|
|  |  |   |   |
| <b>CNC Aluminum endcap</b><br>Code: U20-CAP-N      | <b>Suspension kits</b><br>Code: Sus.KitsA      | <b>Metal clip</b><br>Code: US20-CLIP-M (optional) | <b>Aluminum diffuser</b><br>Code: U20-AD (optional) |
|  |  |   |   |
| <b>Aluminum endcap</b><br>Code: U20-CAP (optional) | <b>Joiner 60°B</b><br>Code: J-60B (optional)   | <b>Joiner 90°A</b><br>Code: J-90A (optional)      | <b>Joiner 90°B</b><br>Code: J-90B (optional)        |
|  |  |   |   |
| <b>Joiner 120°A</b><br>Code: J-120A (optional)     | <b>Joiner 120°B</b><br>Code: J-120B (optional) | <b>Joiner 180°A</b><br>Code: J-180A (optional)    |   |

**LW-UST20** NEW

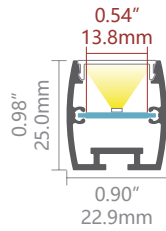

**PMMA Diffuser**

Code: U20-O (Opal, light trans. > 64%)  
 Code: U20-B (Black, light trans. > 23%)

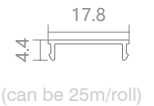

**Accessories**

- |   |   |
|---|---|
|   |   |
| <b>CNC Aluminum endcap</b><br>Code: UST20-CAP-N | <b>Suspension kits</b><br>Code: Sus.KitsA |

**LW-UST23** NEW

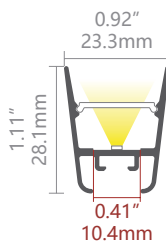
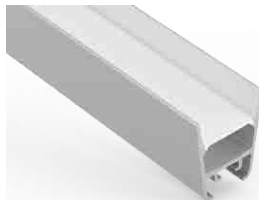

**PMMA Diffuser**

Code: AT15-O (Opal, light trans. > 65%)

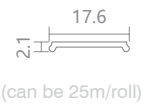

**Accessories**

- |   |  |  |  |
|---|--|--|--|
|   |  |  |  |
| <b>CNC Aluminum endcap</b><br>Code: UST23-CAP-N | <b>Suspension kits</b><br>Code: Sus.KitsA      | <b>Joiner 60°B</b><br>Code: J-60B (optional)   | <b>Joiner 90°A</b><br>Code: J-90A (optional)   |
|   |  |  |  |
| <b>Joiner 90°B</b><br>Code: J-90B (optional)    | <b>Joiner 120°A</b><br>Code: J-120A (optional) | <b>Joiner 120°B</b><br>Code: J-120B (optional) | <b>Joiner 180°A</b><br>Code: J-180A (optional) |

**LW-C25H**

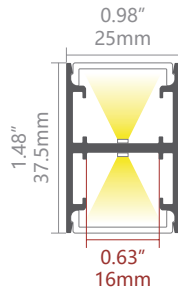

**PMMA Diffuser**

Code: P24-N (New opal, light trans. > 65%)

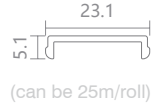

**Accessories**



**CNC Aluminum endcap**  
Code: C25H-CAP-N



**Suspension kits**  
Code: Sus.KitsA (optional)



**Joiner 90°B**  
Code: J-90B (optional)



**Joiner 180°B**  
Code: J-180B (optional)

**LW-AT15**

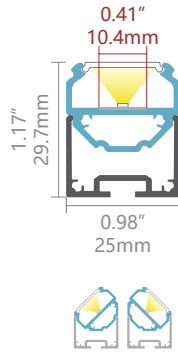

**PMMA Diffuser**

Code: AT15-O (Opal, light trans. > 65%)

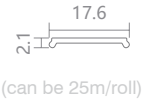

**Accessories**



**Aluminium endcap**  
Code: AT15-CAP  
Code: AT15-CAP-H



**Suspension kits**  
Code: Sus.KitsA (optional)



**Joiner 90°A**  
Code: J-90A (optional)



**Joiner 90°B**  
Code: J-90B (optional)



**Joiner 120°A**  
Code: J-120A (optional)



**Joiner 120°B**  
Code: J-120B (optional)



**Joiner 180°A**  
Code: J-180A (optional)

**LW-AT15-30**

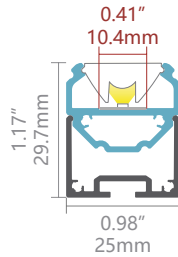

**PMMA Diffuser**

Code: AT12N-C (Clear, light trans. > 133%)

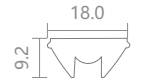

**Accessories**



**Aluminium endcap**  
Code: AT15-CAP  
Code: AT15-CAP-H



**Suspension kits**  
Code: Sus.KitsA (optional)



**Joiner 90°A**  
Code: J-90A (optional)



**Joiner 90°B**  
Code: J-90B (optional)



**Joiner 120°A**  
Code: J-120A (optional)



**Joiner 120°B**  
Code: J-120B (optional)



**Joiner 180°A**  
Code: J-180A (optional)

**LW-AT15-60**

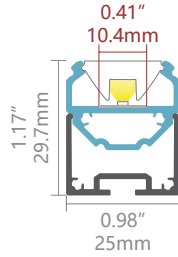







**PMMA Diffuser**

Code: AT12N-C (Clear, light trans. > 133%)



**Accessories**

-   
**Aluminium endcap**  
Code: AT15-CAP  
Code: AT15-CAP-H
-   
**Suspension kits**  
Code: Sus.KitsA (optional)
-   
**Joiner 90°A**  
Code: J-90A (optional)
-   
**Joiner 90°B**  
Code: J-90B (optional)
-   
**Joiner 120°A**  
Code: J-120A (optional)
-   
**Joiner 120°B**  
Code: J-120B (optional)
-   
**Joiner 180°A**  
Code: J-180A (optional)

**LW-AT25-T** NEW

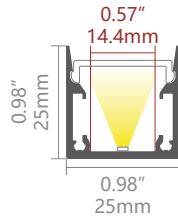

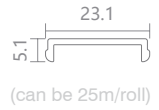

**PMMA Diffuser**

Code: P24-N (New opal, light trans. > 65%)



**Accessories**

-   
**Aluminium Endcap without Hole**  
Code: AT25-T-CAP-N
-   
**Suspension Rods**  
Code: Sus.RodsA
-   
**Joiner 180°B**  
Code: J-180B (optional)

**LW-AT28** EXCLUSIVE IN NZ NEW

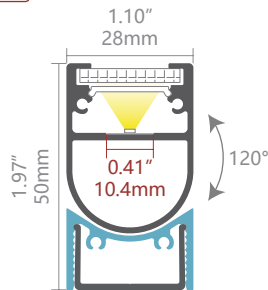

**Honeycomb Diffuser**

Code: WP3-T3-H (Black, light trans. > 43%)



**PMMA Diffuser**

Code: AT15-O (Opal, light trans. > 65%)



**Accessories**

-   
**CNC Aluminum endcap**  
Code: AT28-CAP-H  
Code: AT28-CAP
-   
**Aluminium mounting plate**  
Code: WP3-MP

**LW-CS35D** NEW

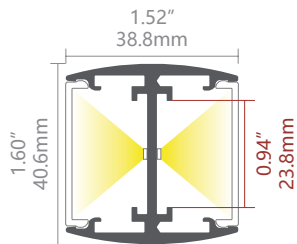

**PMMA Diffuser**

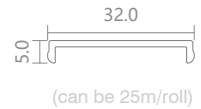

- Code: D005-O (Opal, light trans. > 63%)
- Code: D005-N (New opal, light trans. > 74%)
- Code: D005-F (Frost, light trans. > 89%)
- Code: D005-C (Clear, light trans. > 95%)
- Code: D005-B (Black, light trans. > 20%)



**PC MICRO PRISM Diffuser**

Code: D005-MP (Micro prism, trans. > 66%)

**Accessories**

-   
**CNC Aluminum endcap**  
Code: CS35D-CAP-N
-   
**Suspension kits**  
Code: Sus.KitsA

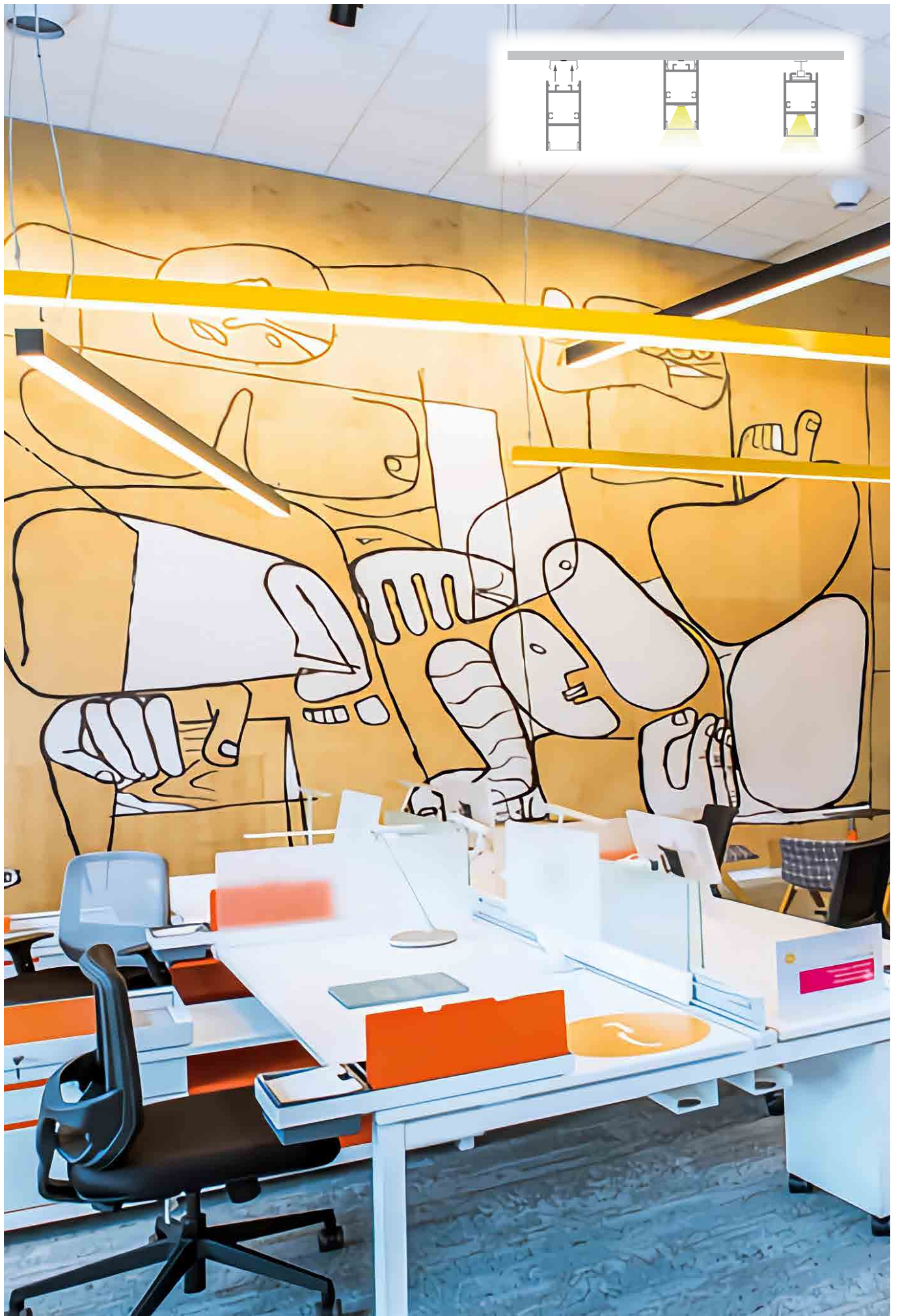

# FLOOR & WATERPROOF

Page 30 - 35

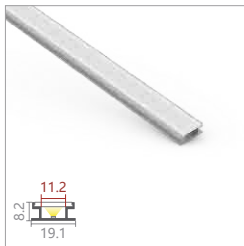
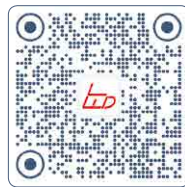

LW-AA

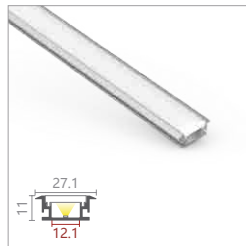

LW-AB

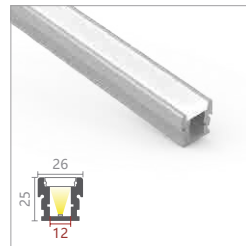

LW-AF1



LW-AF2

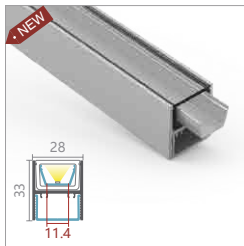

LW-WP3N

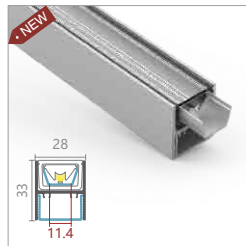

LW-WP3N-30



LW-WP3N-60

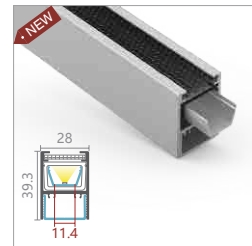

LW-WP3-T3

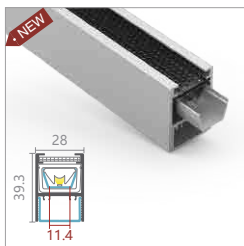

LW-WP3-T3-30



LW-WP3-T3-60

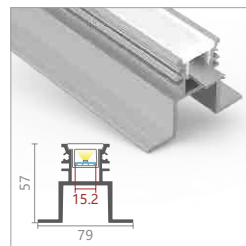

LW-AF3



**LW-AA** IP65



120°

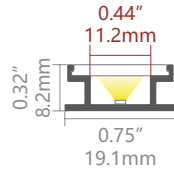

**PC Diffuser**

Code: AA-O (Opal, light trans. > 39%)



**Accessories**



**Plastic endcap**  
Code: AA-CAP  
Code: AA-CAP-H



**Metal clip**  
Code: AA-CLIP-M  
(optional)

**LW-AB** IP65



90°

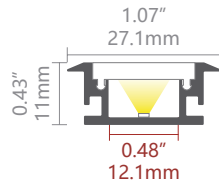

**PC Diffuser**

Code: AB-O (Opal, light trans. > 54%)

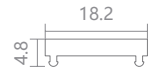

**Accessories**



**Plastic endcap**  
Code: AB-CAP  
Code: AB-CAP-H



**Metal clip**  
Code: AA-CLIP-M  
(optional)

**LW-AF1** IP67 WALK OVER



40°

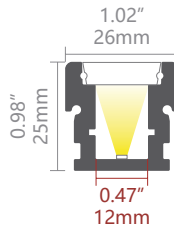

**PC Diffuser**

Code: AA-F (Frost, light trans. > 49%)



**Accessories**



**Plastic endcap**  
Code: AF1-CAP  
Code: AF1-CAP-H



**Metal clip**  
Code: AF1-CLIP-M  
(optional)

**LW-AF2** IP67 DRIVE OVER

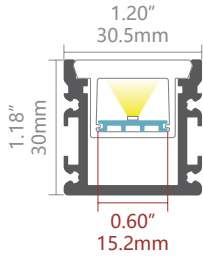

**PC Diffuser**

Code: AF2-O (Opal, light trans. > 45%)

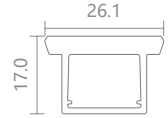

**Accessories**

-   
**Aluminium endcap**  
Code: AF2-CAP  
Code: AF2-CAP-H
-   
**Soft endcap**  
Code: AF2-SCAP  
Code: AF2-SCAP-H
-   
**Waterproof cable gland**  
Code: AF3-WP
-   
**IP68 Waterproof connector**  
Code: AF3-WC (optional)
-   
**IP68 Waterproof box**  
Code: AF3-WB (optional)
-   
**Metal clip**  
Code: AF2-CLIP (optional)
-   
**Joiner 180°A**  
Code: J-180A (optional)

**LW-WP3N** IP67 EXCLUSIVE IN NZ NEW

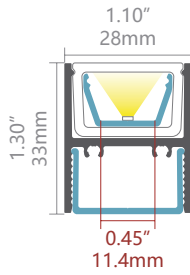



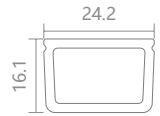

**PMMA Diffuser**

Code: WP3-C (Clear, light trans. > 94%)



**Accessories**

-   
**Aluminium endcap**  
Code: WP3-D-CAP  
Code: WP3-D-CAP-H
-   
**CNC Aluminium endcap**  
Code: WP3-CAP  
Code: WP3-CAP-H
-   
**Aluminium mounting plate**  
Code: WP3-MP
-   
**Suspension kits**  
Code: Sus.KitsA (optional)

**LW-WP3N-30** IP67 EXCLUSIVE IN NZ NEW

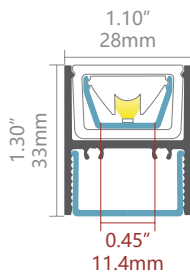

**PMMA Diffuser**

Code: WP3-C (Clear, light trans. > 94%)

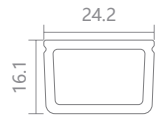





**PMMA Diffuser**

Code: AT12N-C (Clear, light trans. > 133%)



**Accessories**

-   
**Aluminium endcap**  
Code: WP3-D-CAP  
Code: WP3-D-CAP-H
-   
**CNC Aluminium endcap**  
Code: WP3-CAP  
Code: WP3-CAP-H
-   
**Aluminium mounting plate**  
Code: WP3-MP
-   
**Suspension kits**  
Code: Sus.KitsA (optional)

**LW-WP3N-60** IP67 EXCLUSIVE IN NZ NEW

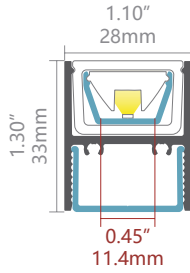

**PMMA Diffuser**

Code: WP3-C (Clear, light trans. > 94%)

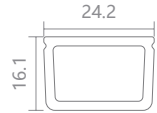

**PMMA Diffuser**

Code: AT12N-C (Clear, light trans. > 133%)



**Accessories**



**Aluminium endcap**  
Code: WP3-D-CAP  
Code: WP3-D-CAP-H



**CNC Aluminium endcap**  
Code: WP3-CAP  
Code: WP3-CAP-H



**Aluminium mounting plate**  
Code: WP3-MP



**Suspension kits**  
Code: Sus.KitsA (optional)

**LW-WP3-T3** IP67 EXCLUSIVE IN NZ NEW

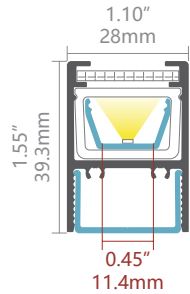

**Honeycomb Diffuser**

Code: WP3-T3-H (Black, light trans. > 43%)



**PMMA Diffuser**

Code: WP3-C (Clear, light trans. > 94%)

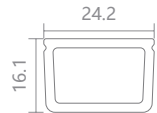

**Accessories**



**Aluminium endcap**  
Code: WP3-D-CAP  
Code: WP3-D-CAP-H



**Aluminium mounting plate**  
Code: WP3-MP



**Aluminium endcap**  
Code: WP3-T3-CAP  
Code: WP3-T3-CAP-H



**Suspension kits**  
Code: Sus.KitsA (optional)

**LW-WP3-T3-30** IP67 EXCLUSIVE IN NZ NEW

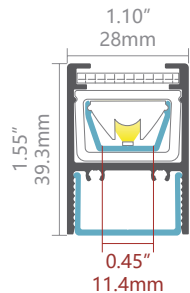
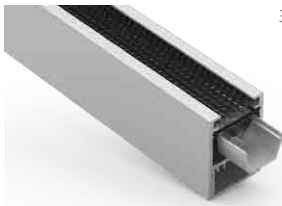

**Honeycomb Diffuser**

Code: WP3-T3-H (Black, light trans. > 43%)



**PMMA Diffuser**

Code: WP3-C (Clear, light trans. > 94%)

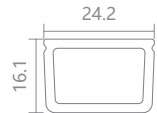

**PMMA Diffuser**

Code: AT12N-C (Clear, light trans. > 133%)



**Accessories**



**Aluminium endcap**  
Code: WP3-D-CAP  
Code: WP3-D-CAP-H



**Aluminium mounting plate**  
Code: WP3-MP



**Aluminium endcap**  
Code: WP3-T3-CAP  
Code: WP3-T3-CAP-H



**Suspension kits**  
Code: Sus.KitsA (optional)

**LW-WP3-T3-60** IP67 EXCLUSIVE IN NZ NEW

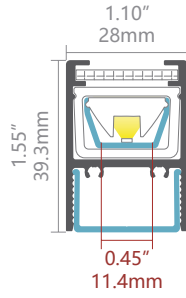

**Honeycomb Diffuser**

Code: WP3-T3-H (Black, light trans. > 43%)

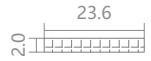

**PMMA Diffuser**

Code: WP3-C (Clear, light trans. > 94%)

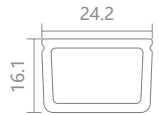

**PMMA Diffuser**

Code: AT12N-C (Clear, light trans. > 133%)

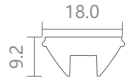

**Accessories**



**Aluminium endcap**  
Code: WP3-D-CAP  
Code: WP3-D-CAP-H



**Aluminium mounting plate**  
Code: WP3-MP



**Aluminium endcap**  
Code: WP3-T3-CAP  
Code: WP3-T3-CAP-H



**Suspension kits**  
Code: Sus.KitsA (optional)

**LW-AF3** IP67 DRIVE OVER

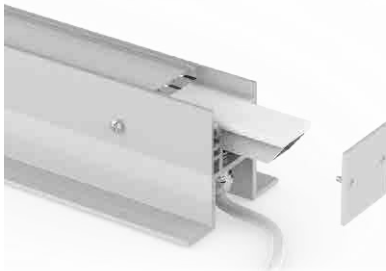
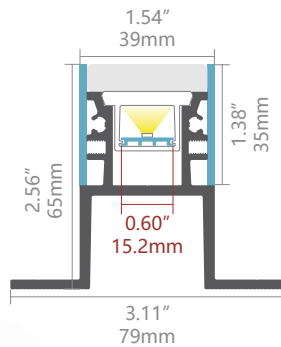
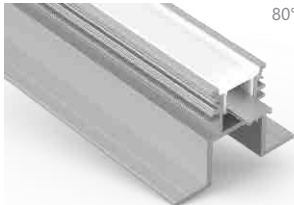

**PC Diffuser**

Code: AF2-O (Opal, light trans. > 45%)

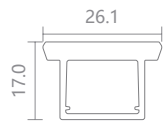

**Accessories**



**Stainless steel endcap**  
Code: AF3-CAP



**Soft endcap**  
Code: AF2-SCAP  
Code: AF2-SCAP-H



**Glass diffuser, max 1.25M**  
Code: AF3-GLASS



**Stainless steel side bar, max 1.25M**  
Code: AF3-SB



**Waterproof cable gland**  
Code: AF3-WP



**IP68 Waterproof connector**  
Code: AF3-WC (optional)



**IP68 Waterproof box**  
Code: AF3-WB (optional)



**Joiner 180°**  
Code: J-180 (optional)



**Joiner 90°**  
Code: J-180 (optional)

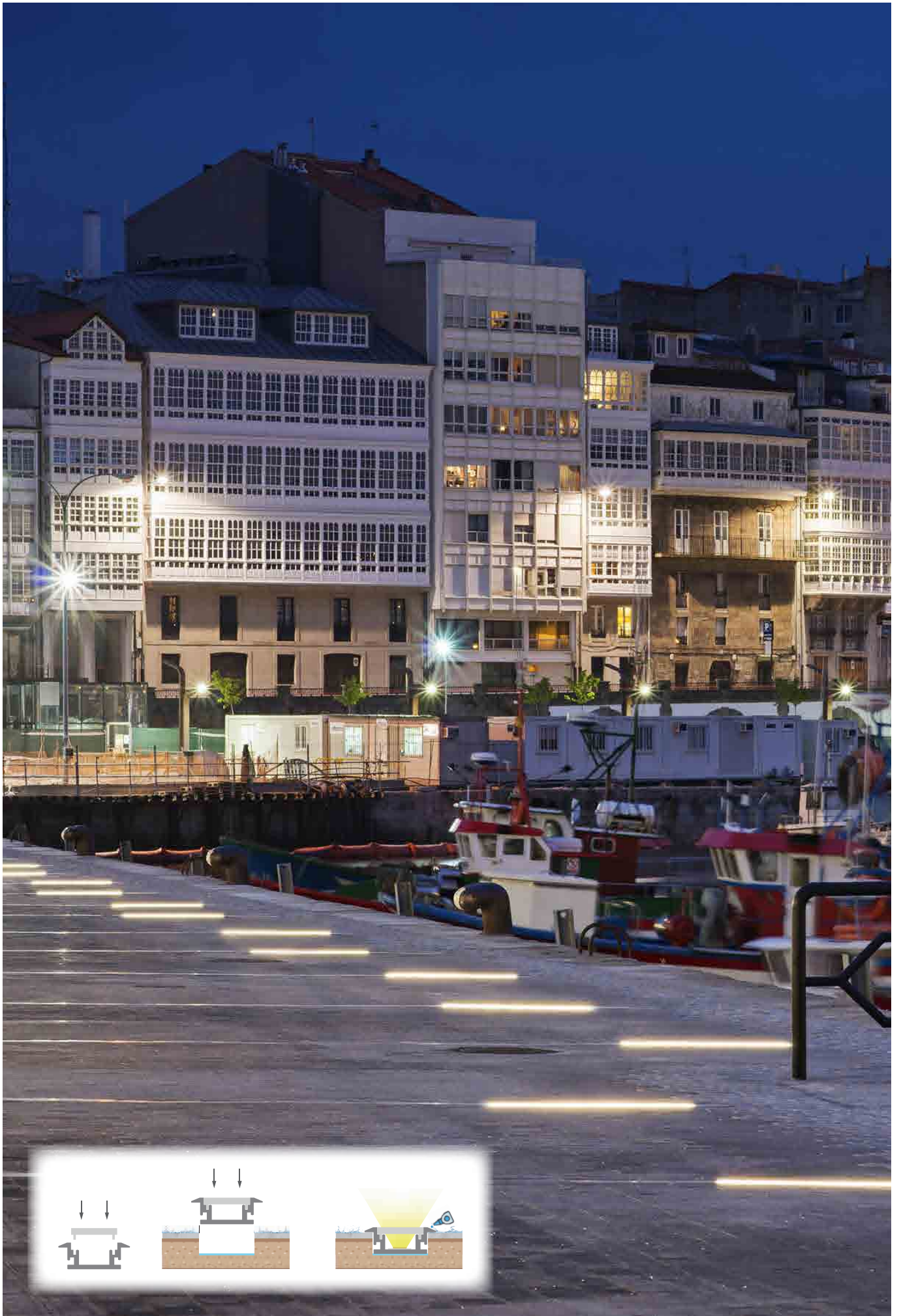

# STAIR & STEP

Page 36 - 38

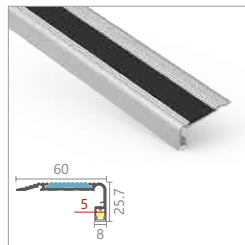
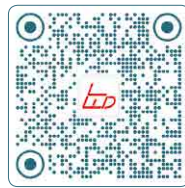

LW-ST2

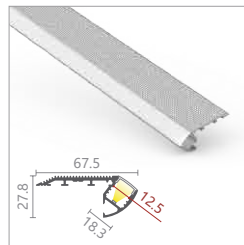

LW-ST1

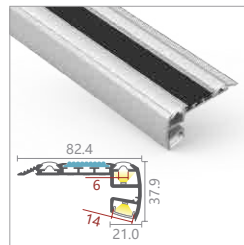

LW-STR3

### LW-ST2

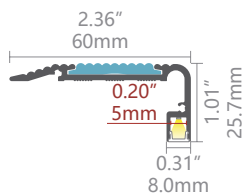

#### PC Diffuser

Code: AS9-O (Opal, light trans. > 45%)



#### PMMA Diffuser

Code: AS9-B (Black, light trans. > 24%)

(can be 25m/roll)

#### Accessories



#### Plastic endcap

Code: ST2-CAP-R  
Code: ST2-CAP-L



#### 25mm Anti-slip rubber

Code: ST2-ASRUB  
25mm

### LW-ST1

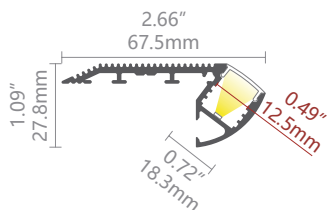
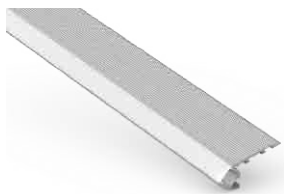

#### PC Diffuser

Code: D001-O (Opal, light trans. > 60%)



(can be 25m/roll)

#### PMMA Diffuser

Code: D001-B (Black, light trans. > 21%)

#### Accessories



#### Plastic endcap

Code: ST1-CAP-R  
Code: ST1-CAP-L

### LW-STR3

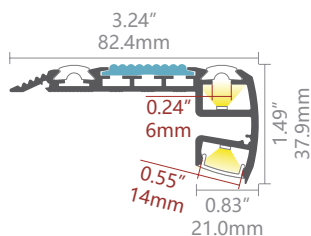

#### PC Diffuser

Code: D001-O (Opal, light trans. > 60%)



(can be 25m/roll)

#### PMMA Diffuser

Code: D001-B (Black, light trans. > 21%)

#### Accessories



#### Plastic endcap

Code: STR3-CAP-R  
Code: STR3-CAP-L



#### 25mm Anti-slip rubber

Code: ST2-ASRUB  
25mm



#### Anti-slip rubber

Code: STR3-ASRUB

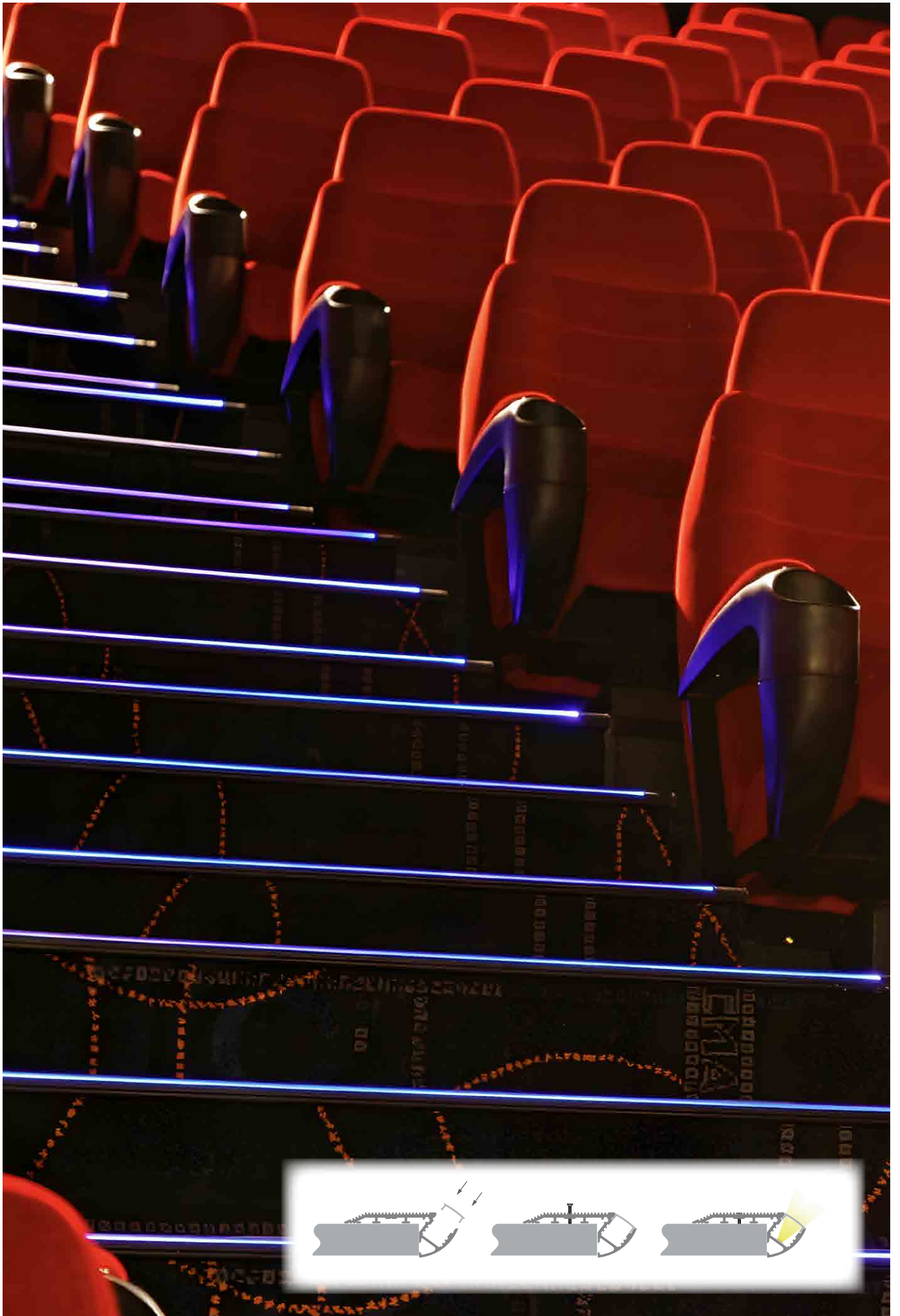



# TUBE & WARDROBE

Page 39 - 41

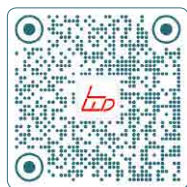

LW-R24



LW-R24-T



LW-R30



LW-R34



LW-R57



LW-R60



LW-R75

**LW-R24**

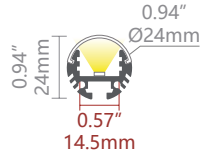

**PC Diffuser**

Code: R24-O (Opal, light trans. > 47%)  
Code: R24-F (Frost, light trans. > 56%)



**Accessories**

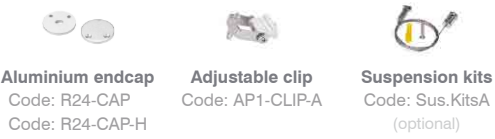

**LW-R24-T** NEW

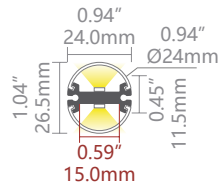

**PC Diffuser**

Code: R24-O (Opal, light trans. > 47%)  
Code: R24-F (Frost, light trans. > 56%)



**Accessories**

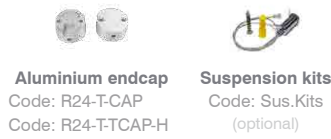

**LW-R30**

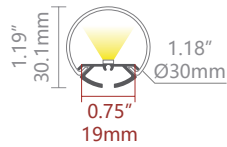

**PC Diffuser**

Code: R30-O (Opal, light trans. > 79%)

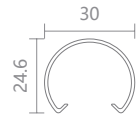

**Accessories**

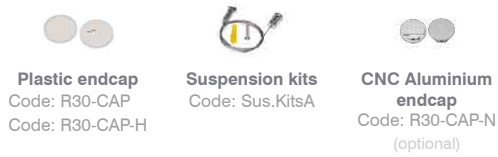

**LW-R34**

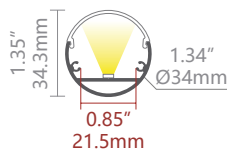

**PC Diffuser**

Code: R34-O (Opal, light trans. > 40%)  
Code: R34-F (Frost, light trans. > 45%)

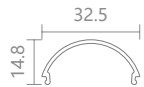

**PMMA Diffuser**

Code: R34-B (Black, light trans. > 25%)

**Accessories**



**LW-R57**

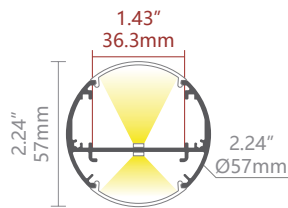

**PC Diffuser**

Code: R57-O (Opal, light trans. > 74%)



**Accessories**



**LW-R60**



165°

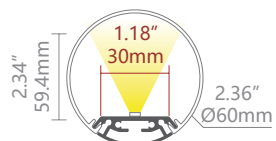

**PC Diffuser**

Code: R60-O (Opal, light trans. > 74%)

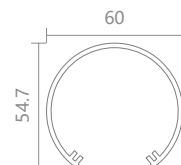

**Accessories**



**Plastic endcap**  
Code: R60-CAP



**Suspension kits**  
Code: Sus.KitsA



**Surface mounting kits**  
Code: R60-MOUNTING KITS



**CNC Aluminium endcap**  
Code: R60-CAP-N (optional)



**Joiner 180°A**  
Code: J-180A (optional)

**LW-R75**

**NEW**



360°

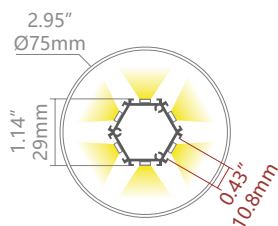
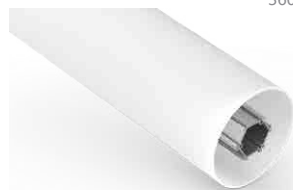

**PC Diffuser**

Code: R75-O (Opal, light trans. > 70%)

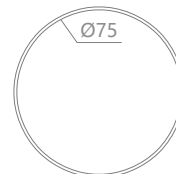

**Accessories**



**Plastic endcap**  
Code: R75-CAP  
Code: R75-CAP-H



**Suspension kits**  
Code: Sus.KitsA

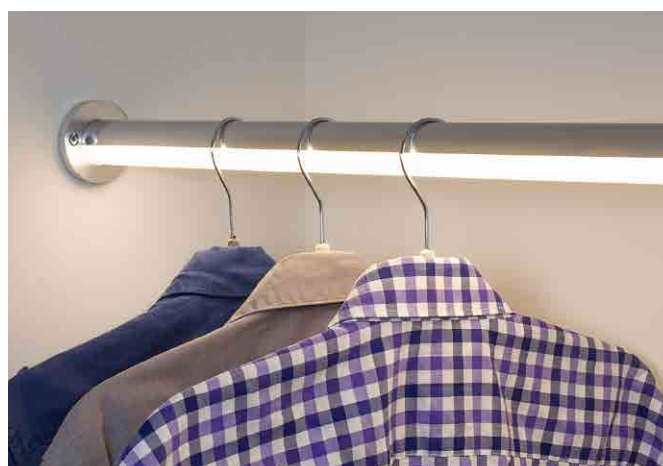

# WALL

Page 42 - 45

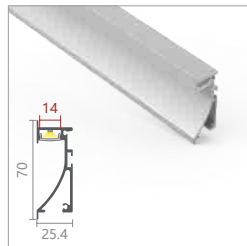
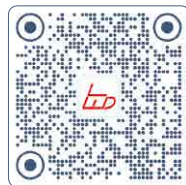

LW-AW1

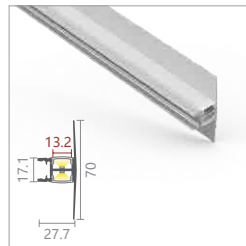

LW-AW2



LW-AW8

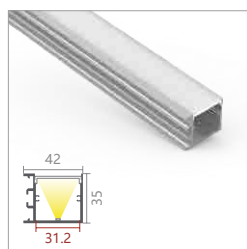

LW-AW35

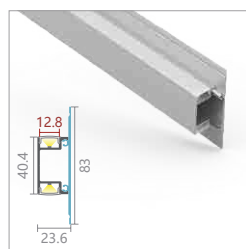

LW-AW4-1

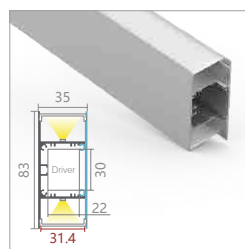

LW-AW5-1

### LW-AW1



100°



### PMMA Diffuser

- Code: D001-O (Opal, light trans. > 58%)
- Code: D001-M (Milky, light trans. > 75%)
- Code: D001-F (Frost, light trans. > 88%)
- Code: D001-C (Clear, light trans. > 97%)
- Code: D001-B (Black, light trans. > 21%)



(can be 25m/roll)

### Accessories



**Aluminium endcap**  
Code: AW1-CAP-L  
Code: AW1-CAP-R



**Spring clip**  
Code: SC-AW1



**Metal clip**  
Code: AW1-CLIP-M  
(optional)

### LW-AW2



60°

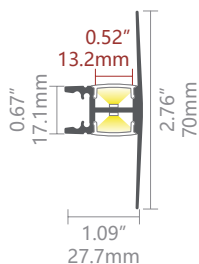

### PMMA Diffuser

- Code: D001-O (Opal, light trans. > 58%)
- Code: D001-M (Milky, light trans. > 75%)
- Code: D001-F (Frost, light trans. > 88%)
- Code: D001-C (Clear, light trans. > 97%)
- Code: D001-B (Black, light trans. > 21%)



(can be 25m/roll)

### Accessories



**Aluminium endcap**  
Code: AW2-CAP  
Code: AW2-CAP-H



**Metal clip**  
Code: AS1-CLIP-M

### LW-AW8



80°

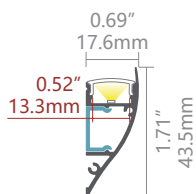

### PC Diffuser

- Code: AW8-O (Opal, light trans. > 71%)



### Accessories



**Aluminium endcap**  
Code: AW8-CAP-L  
Code: AW8-CAP-R



**Mounting plate**  
Code: AW8-ALU-PLATE

### LW-AW35

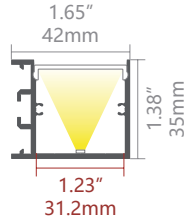

### PMMA Diffuser

- Code: D005-O (Opal, light trans. > 63%)
- Code: D005-N (New opal, light trans. > 74%)
- Code: D005-F (Frost, light trans. > 89%)
- Code: D005-C (Clear, light trans. > 95%)
- Code: D005-B (Black, light trans. > 20%)

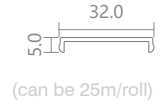

### PC MICRO PRISM Diffuser

- Code: D005-MP (Micro prism, trans. > 66%)

### Accessories

 <b>CNC Aluminium endcap</b> Code: AW35-CAP-N	 <b>Metal clip</b> Code: WN35-CLIP-M	 <b>Aluminium diffuser</b> Code: D005-AD (optional)	 <b>Joiner 90°A</b> Code: J-90A (optional)
 <b>Joiner 90°B</b> Code: J-90B (optional)	 <b>Joiner 120°A</b> Code: J-120A (optional)	 <b>Joiner 120°B</b> Code: J-120B (optional)	 <b>Joiner 180°A</b> Code: J-180A (optional)

### LW-AW4-1

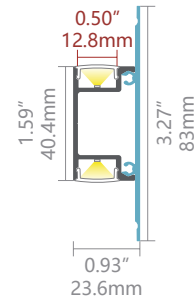
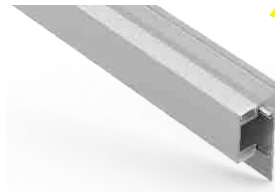

### PMMA Diffuser

- Code: D001-O (Opal, light trans. > 58%)
- Code: D001-M (Milky, light trans. > 75%)
- Code: D001-F (Frost, light trans. > 88%)
- Code: D001-C (Clear, light trans. > 97%)
- Code: D001-B (Black, light trans. > 21%)

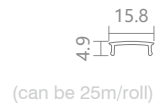

### Accessories

 <b>Aluminium endcap</b> Code: AW4-1-CAP
---

### LW-AW5-1

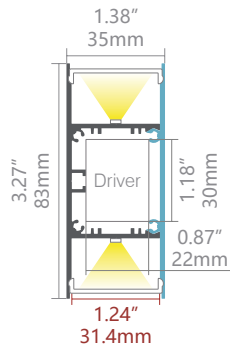
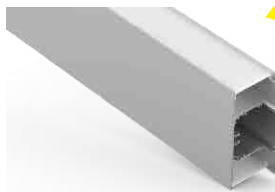

### PMMA Diffuser

- Code: D005-O (Opal, light trans. > 63%)
- Code: D005-N (New opal, light trans. > 74%)
- Code: D005-F (Frost, light trans. > 89%)
- Code: D005-C (Clear, light trans. > 95%)
- Code: D005-B (Black, light trans. > 20%)

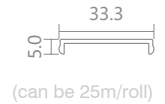

### PC MICRO PRISM Diffuser

- Code: D005-MP (Micro prism, trans. > 66%)

### Accessories

 <b>Aluminium endcap</b> Code: AW5-1-CAP	 <b>Wall clip</b> Code: WCLIP (optional)	 <b>Aluminium diffuser</b> Code: D005-AD (optional)	 <b>Suspension kits</b> Code: Sus.KitsA (optional)
---	---	--	---



# DRIVER BUILT-IN

Page 46 - 51

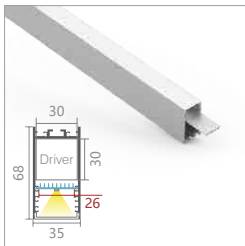
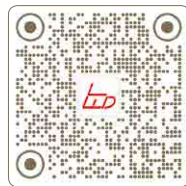

LW-P35

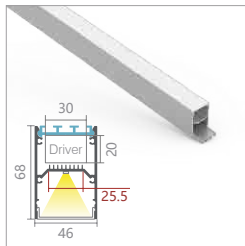

LW-P46

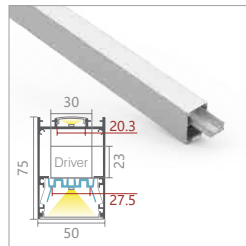

LW-P50N

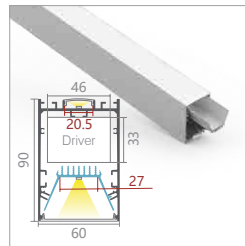

LW-P60

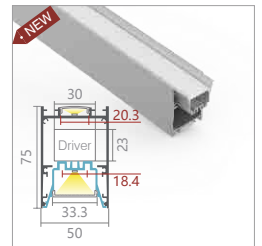

LW-P50N-S

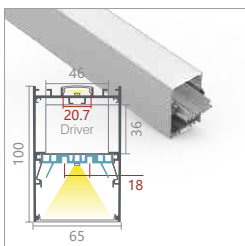

LW-P65

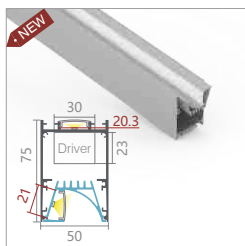

LW-P50N-B

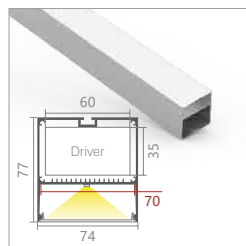

LW-P74

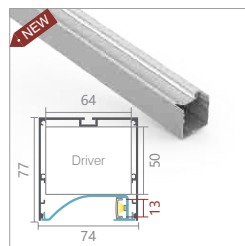

LW-P74N

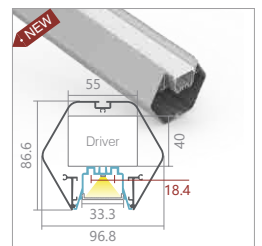

LW-HG87



## LW-P35

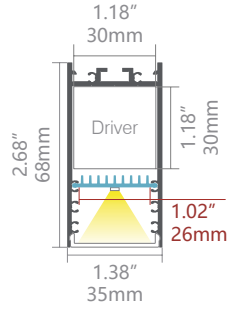

### PMMA Diffuser



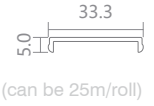

- Code: D005-O (Opal, light trans. > 63%)
- Code: D005-N (New opal, light trans. > 74%)
- Code: D005-F (Frost, light trans. > 89%)
- Code: D005-C (Clear, light trans. > 95%)
- Code: D005-B (Black, light trans. > 20%)



### PC MICRO PRISM Diffuser

- Code: D005-MP (Micro prism, trans. > 66%)

### Accessories

		
<b>Aluminium endcap</b> Code: P35-CAP	<b>Suspension kits</b> Code: Sus.KitsA	<b>Aluminum diffuser</b> Code: D005-AD (optional)
		
<b>CNC Aluminium endcap</b> Code: P35-CAP-N (optional)	<b>Metal clip</b> Code: WN35-CLIP-M (optional)	<b>Wall clip</b> Code: WCLIP (optional)
		
<b>Joiner 90°A</b> Code: J-90A (optional)	<b>Joiner 120°A</b> Code: J-120A (optional)	<b>Joiner 180°A</b> Code: J-180A (optional)

## LW-P46

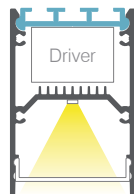
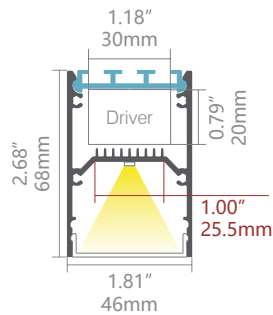

### PMMA Diffuser

- Code: P46-N (New opal, light trans. > 74%)



### Accessories

			
<b>Aluminium endcap</b> Code: P46-CAP	<b>Suspension kits</b> Code: Sus.KitsA	<b>CNC Aluminium endcap</b> Code: P46-CAP-N (optional)	<b>Wall clip</b> Code: WCLIP (optional)
			
<b>Joiner 90°A</b> Code: J-90A (optional)	<b>Joiner 120°A</b> Code: J-120A (optional)	<b>Joiner 180°A</b> Code: J-180A (optional)	

### LW-P50N

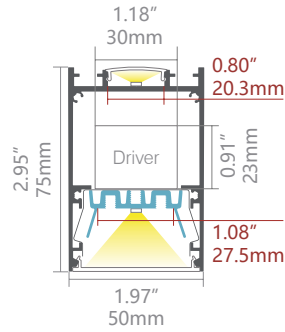

### PMMA Diffuser(Up)

Code: D003-O	(Opal, light trans. > 70%)	22.3
Code: D003-M	(Milky, light trans. > 78%)	5.4
Code: D003-F	(Frost, light trans. > 91%)	(can be 25m/roll)
Code: D003-C	(Clear, light trans. > 94%)	
Code: D003-B	(Black, light trans. > 20%)	







### PMMA Diffuser(Down)

Code: D050-O	(Opal, light trans. > 68%)	46.6
Code: D050-N	(New opal, light trans. > 74%)	5.5
Code: D050-B	(Black, light trans. > 22%)	(can be 25m/roll)

### PC MICRO PRISM Diffuser(Down)

Code: D050-MP	(Micro prism, trans. > 62%)	
---------------	-----------------------------	--

### Accessories

 <b>CNC Aluminium endcap</b> Code: P50N-CAP-N	 <b>Suspension kits</b> Code: Sus.KitsB	 <b>Gear tray clip</b> Code: P50N-CLIP-GEAR TRAY	 <b>Aluminum diffuser</b> Code: D050-AD (optional)
 <b>Aluminium endcap</b> Code: P50-CAP (optional)	 <b>Metal clip</b> Code: P50N-CLIP-M (optional)	 <b>Wall clip</b> Code: WCLIP (optional)	 <b>Joiner 90°A</b> Code: J-90A (optional)
 <b>Joiner 90°B</b> Code: J-90B (optional)	 <b>Joiner 120°A</b> Code: J-120A (optional)	 <b>Joiner 120°B</b> Code: J-120B (optional)	 <b>Joiner 180°A</b> Code: J-180A (optional)
 <b>Joiner 180°B</b> Code: J-180B (optional)	 <b>L type stainless steel bracket</b> Code: LW-LMB (optional)		

### LW-P60

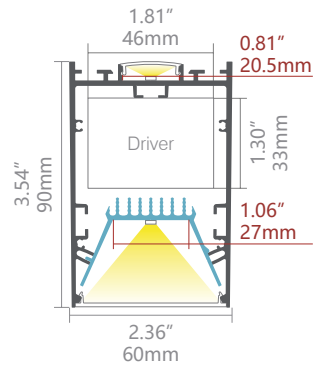

### PMMA Diffuser(Up)

Code: D003-O	(Opal, light trans. > 70%)	22.3
Code: D003-M	(Milky, light trans. > 78%)	5.4
Code: D003-F	(Frost, light trans. > 91%)	(can be 25m/roll)
Code: D003-C	(Clear, light trans. > 94%)	
Code: D003-B	(Black, light trans. > 20%)	

### PMMA Diffuser(Down)

Code: D060-O	(Opal, light trans. > 65%)	56.6
Code: D060-N	(New opal, light trans. > 74%)	5.5
		(can be 25m/roll)

### PC MICRO PRISM Diffuser(Down)

Code: D060-MP	(Micro prism, trans. > 65%)	
---------------	-----------------------------	--

### Accessories

 <b>Aluminium endcap</b> Code: P60-CAP	 <b>Suspension kits</b> Code: Sus.KitsB	 <b>Aluminum diffuser</b> Code: D060-AD (optional)	 <b>CNC Aluminium endcap</b> Code: P60-CAP-N (optional)
 <b>Wall clip</b> Code: WCLIP (optional)	 <b>Joiner 90°A</b> Code: J-90A (optional)	 <b>Joiner 90°B</b> Code: J-90B (optional)	 <b>Joiner 120°A</b> Code: J-120A (optional)
 <b>Joiner 120°B</b> Code: J-120B (optional)	 <b>Joiner 180°A</b> Code: J-180A (optional)		

**LW-P50N-S** NEW

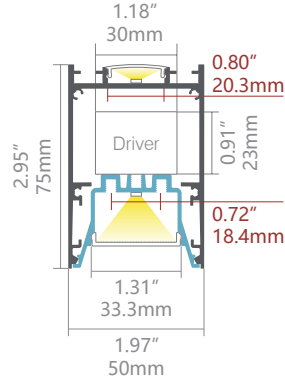

**PMMA Diffuser(Up)**

- Code: D003-O (Opal, light trans. > 70%)
- Code: D003-M (Milky, light trans. > 78%)
- Code: D003-F (Frost, light trans. > 91%)
- Code: D003-C (Clear, light trans. > 94%)
- Code: D003-B (Black, light trans. > 20%)



(can be 25m/roll)

**PMMA Diffuser(DOWN)**

- Code: D005-O (Opal, light trans. > 63%)
- Code: D005-N (New opal, light trans. > 74%)
- Code: D005-F (Frost, light trans. > 89%)
- Code: D005-C (Clear, light trans. > 95%)
- Code: D005-B (Black, light trans. > 20%)



(can be 25m/roll)

**PC MICRO PRISM Diffuser(DOWN)**

- Code: D005-MP (Micro prism, trans. > 66%)

**Accessories**

 <b>CNC Aluminium endcap</b> Code: P50N-CAP-N	 <b>Aluminium endcap</b> Code: P50-CAP (optional)	 <b>Suspension kits</b> Code: Sus.KitsB	 <b>L type stainless steel bracket</b> Code: LW-LMB (optional)
 <b>Metal clip</b> Code: P50N-CLIP-M (optional)	 <b>Wall clip</b> Code: WCLIP (optional)	 <b>Joiner 90°A</b> Code: J-90A (optional)	 <b>Joiner 90°B</b> Code: J-90B (optional)
 <b>Joiner 120°A</b> Code: J-120A (optional)	 <b>Joiner 120°B</b> Code: J-120B (optional)	 <b>Joiner 180°A</b> Code: J-180A (optional)	 <b>Joiner 180°B</b> Code: J-180B (optional)

**LW-P65**

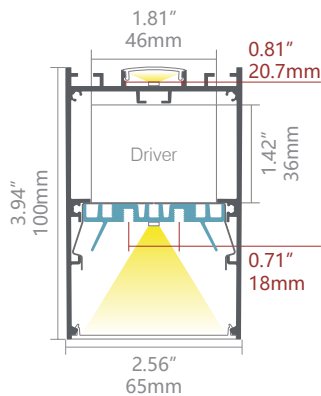

**PMMA Diffuser(Up)**

- Code: D003-O (Opal, light trans. > 70%)
- Code: D003-M (Milky, light trans. > 78%)
- Code: D003-F (Frost, light trans. > 91%)
- Code: D003-C (Clear, light trans. > 94%)
- Code: D003-B (Black, light trans. > 20%)

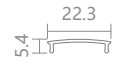

(can be 25m/roll)

**PMMA Diffuser(DOWN)**

- Code: D065-O (Opal, light trans. > 69%)











(can be 25m/roll)

**PC MICRO PRISM Diffuser(DOWN)**

- Code: D065-MP (Micro prism, trans. > 60%)

**Accessories**

 <b>Aluminium endcap</b> Code: P65-CAP	 <b>CNC Aluminium endcap</b> Code: P65-CAP-N (optional)	 <b>Suspension kits</b> Code: Sus.KitsB	 <b>Wall clip</b> Code: WCLIP (optional)
 <b>Joiner 90°A</b> Code: J-90A (optional)	 <b>Joiner 90°B</b> Code: J-90B (optional)	 <b>Joiner 120°A</b> Code: J-120A (optional)	 <b>Joiner 120°B</b> Code: J-120B (optional)
 <b>Joiner 180°A</b> Code: J-180A (optional)			

**LW-P50N-B** NEW

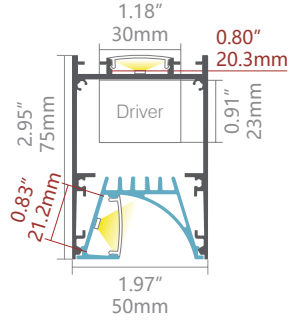
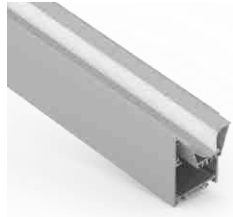

**PMMA Diffuser**

- Code: D003-O (Opal, light trans. > 70%)
- Code: D003-M (Milky, light trans. > 78%)
- Code: D003-F (Frost, light trans. > 91%)
- Code: D003-C (Clear, light trans. > 94%)
- Code: D003-B (Black, light trans. > 20%)



(can be 25m/roll)

**Accessories**

<b>CNC Aluminium endcap (without hole, left)</b> Code: P50N-B-CAP-N-L	<b>Suspension kits</b> Code: Sus.KitsB	<b>CNC Aluminium endcap (without hole, right)</b> Code: P50N-B-CAP-N-R	<b>L type stainless steel bracket</b> Code: LW-LMB (optional)
<b>Metal clip</b> Code: P50N-CLIP-M (optional)	<b>Wall clip</b> Code: WCLIP (optional)	<b>Joiner 90°A</b> Code: J-90A (optional)	<b>Joiner 90°B</b> Code: J-90B (optional)
<b>Joiner 120°A</b> Code: J-120A (optional)	<b>Joiner 120°B</b> Code: J-120B (optional)	<b>Joiner 180°A</b> Code: J-180A (optional)	<b>Joiner 180°B</b> Code: J-180B (optional)

**LW-P74**

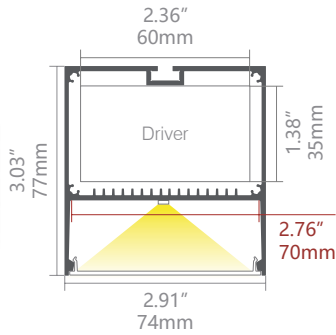

**PMMA Diffuser**

- Code: P74-O (Opal, light trans. > 65%)

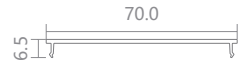

**Accessories**

<b>Aluminium endcap</b> Code: P74-CAP	<b>Suspension kits</b> Code: Sus.KitsA	<b>L type stainless steel bracket</b> Code: LW-LMB (optional)	<b>Wall clip</b> Code: WCLIP (optional)
<b>Joiner 90°A</b> Code: J-90A (optional)	<b>Joiner 120°A</b> Code: J-120A (optional)	<b>Joiner 180°A</b> Code: J-180A (optional)	

**LW-P74N** NEW

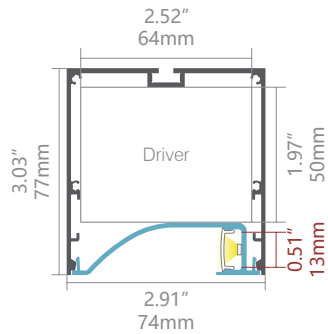

**PMMA Diffuser**

- Code: D001-O (Opal, light trans. > 58%)
- Code: D001-M (Milky, light trans. > 75%)
- Code: D001-F (Frost, light trans. > 88%)
- Code: D001-C (Clear, light trans. > 97%)
- Code: D001-B (Black, light trans. > 21%)

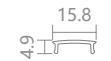

(can be 25m/roll)

**Accessories**

<b>Aluminium endcap</b> Code: P74N-CAP	<b>Suspension kits</b> Code: Sus.KitsA	<b>L type stainless steel bracket</b> Code: LW-LMB (optional)	<b>Wall clip</b> Code: WCLIP (optional)
<b>Joiner 90°A</b> Code: J-90A (optional)	<b>Joiner 90°B</b> Code: J-90B (optional)	<b>Joiner 180°A</b> Code: J-180A (optional)	<b>Joiner 180°B</b> Code: J-180B (optional)

**LW-HG87** NEW



75°

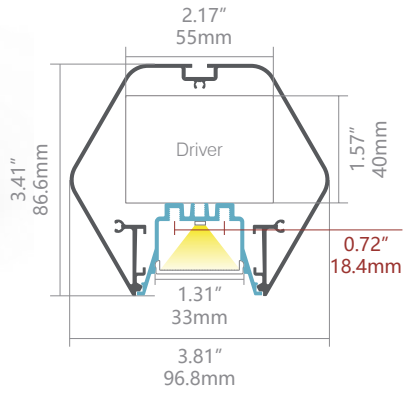

**PMMA Diffuser**

- Code: D005-O (Opal, light trans. > 63%)
- Code: D005-N (New opal, light trans. > 74%)
- Code: D005-F (Frost, light trans. > 89%)
- Code: D005-C (Clear, light trans. > 95%)
- Code: D005-B (Black, light trans. > 20%)

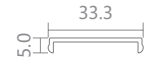

(can be 25m/roll)

**PC MICRO PRISM Diffuser**

- Code: D005-MP (Micro prism, trans. > 66%)

**Accessories**

- Aluminium endcap without hole**  
Code: HG87-CAP
- Suspension kits**  
Code: Sus.KitsA
- Joiner 90°A**  
Code: J-90A (optional)
- Joiner 90°B**  
Code: J-90B (optional)
- Joiner 180°A**  
Code: J-180A (optional)
- Joiner 180°B**  
Code: J-180B (optional)

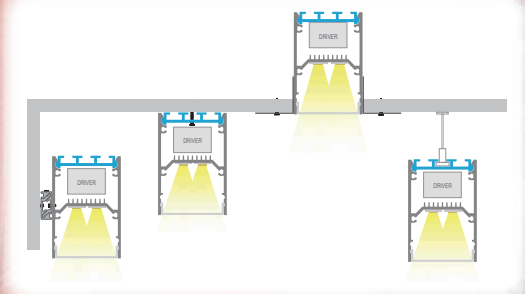
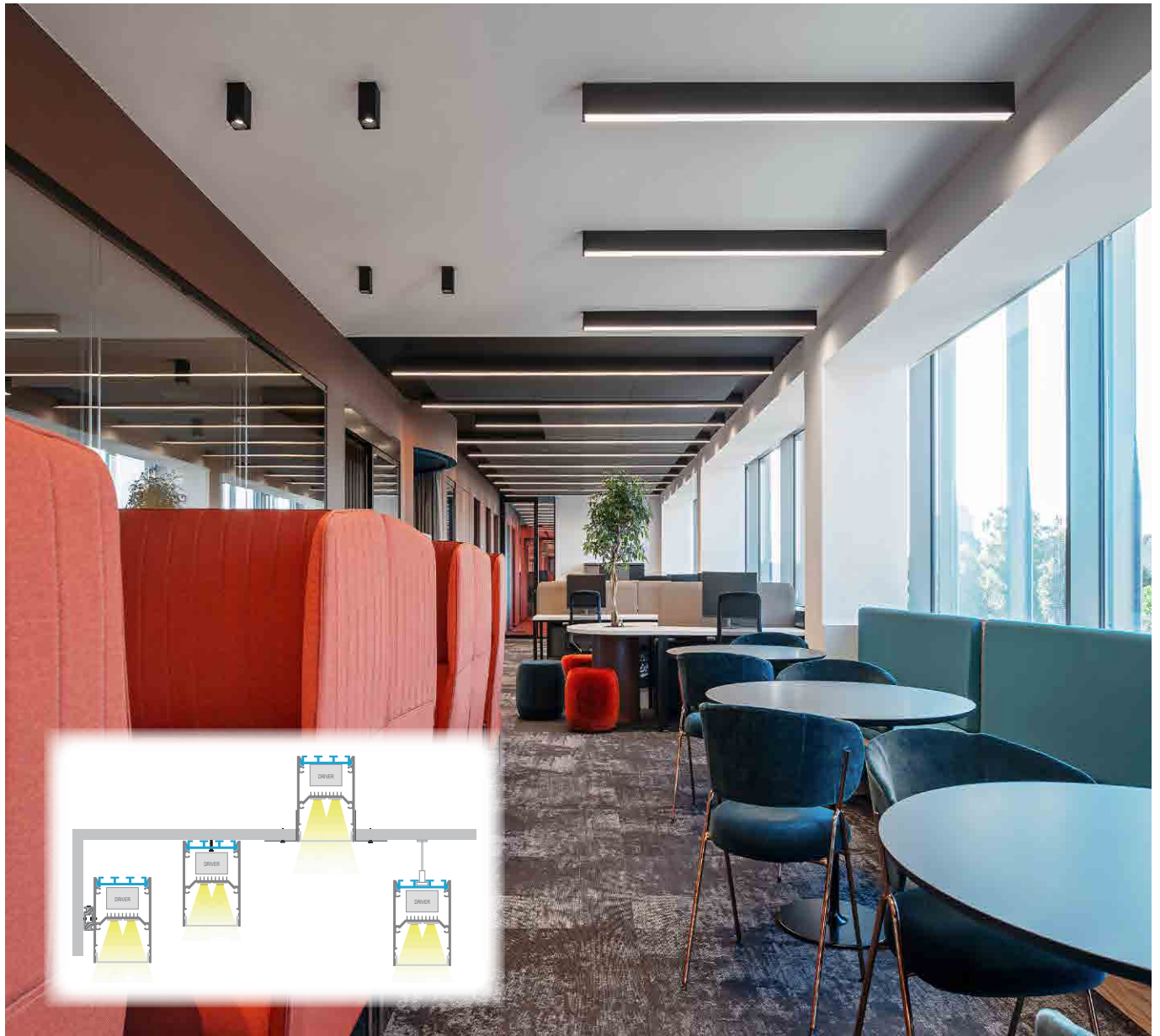

# TRIMLESS -ARCHITECTURAL

Page 52 - 55

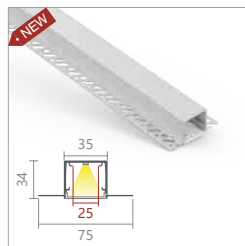
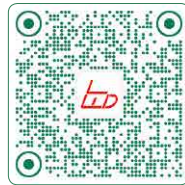

LW-TR35N

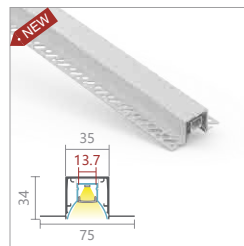

LW-TR35N-S1

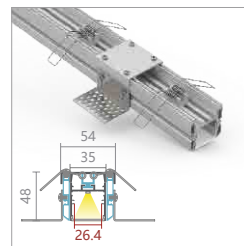

LW-TR35

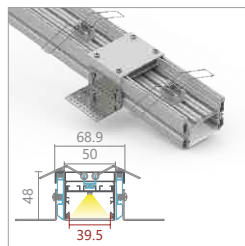

LW-TR50

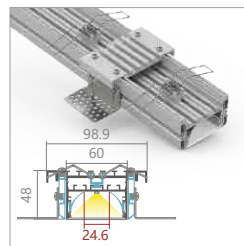

LW-TR60

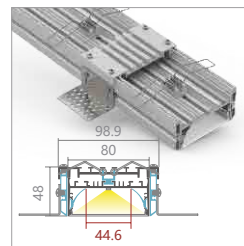

LW-TR80

**LW-TR35N** NEW

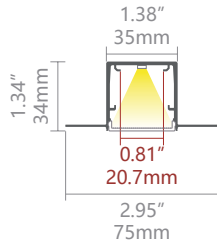

**PMMA Diffuser**

- Code: D005-O (Opal, light trans. > 63%)
- Code: D005-N (New opal, light trans. > 74%)
- Code: D005-F (Frost, light trans. > 89%)
- Code: D005-C (Clear, light trans. > 95%)
- Code: D005-B (Black, light trans. > 20%)

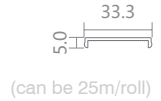

**PC MICRO PRISM Diffuser**

- Code: D005-MP (Micro prism, trans. > 66%)

**Accessories**

- Aluminium endcap**  
 Code: TR35N-CAP
- Aluminum diffuser**  
 Code: D005-AD  
 (optional)
- Joiner 90°**  
 Code: J-90  
 (optional)
- Joiner 120°**  
 Code: J-120  
 (optional)
- Joiner 180°**  
 Code: J-180  
 (optional)

**LW-TR35N-S1** NEW

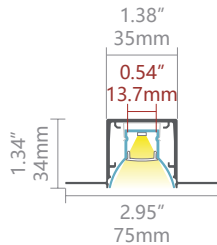

**PMMA Diffuser**

- Code: D001-O (Opal, light trans. > 58%)
- Code: D001-M (Milky, light trans. > 75%)
- Code: D001-F (Frost, light trans. > 88%)
- Code: D001-C (Clear, light trans. > 97%)
- Code: D001-B (Black, light trans. > 21%)



**Accessories**

- Aluminium endcap**  
 Code: TR35N-S1-CAP
- Joiner 90°**  
 Code: J-90  
 (optional)
- Joiner 120°**  
 Code: J-120  
 (optional)
- Joiner 180°**  
 Code: J-180  
 (optional)
- Metal clip**  
 Code: AS1-CLIP-M

**LW-TR35**

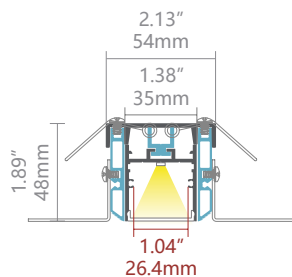
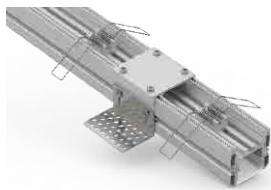

**PMMA Diffuser**

- Code: D005-O (Opal, light trans. > 63%)
- Code: D005-N (New opal, light trans. > 74%)
- Code: D005-F (Frost, light trans. > 89%)
- Code: D005-C (Clear, light trans. > 95%)
- Code: D005-B (Black, light trans. > 20%)

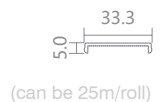

**PC MICRO PRISM Diffuser**

- Code: D005-MP (Micro prism, trans. > 66%)

**Accessories**

- CNC Aluminium endcap**  
 Code: WN35-CAP-N
- Aluminium endcap**  
 Code: TR35-CAP
- Spring clip**  
 Code: SC-WN31
- Trimless bar**  
 Code: LW-TR1
- L type stainless steel bracket**  
 Code: LW-LMB
- Bridge base**  
 Code: LW-AB35
- Aluminum diffuser**  
 Code: D005-AD  
 (optional)
- Joiner 90°A**  
 Code: J-90A  
 (optional)
- Joiner 120°A**  
 Code: J-120A  
 (optional)
- Joiner 180°A**  
 Code: J-180A  
 (optional)

### LW-TR50

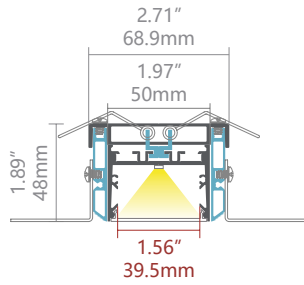
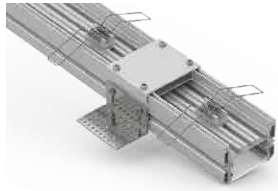

#### PMMA diffuser

- Code: D050-O (Opal, light trans. > 68%)
- Code: D050-N (New opal, light trans. > 74%)
- Code: D050-B (Black, light trans. > 22%)

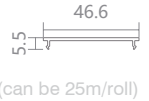

#### PC MICRO PRISM Diffuser

- Code: D050-MP (Micro prism, trans. > 62%)

#### Accessories

 Aluminium endcap Code: E50-CAP	 Aluminium endcap Code: TR50-CAP	 Spring clip Code: SC-WN31	 Trimless bar Code: LW-TR1
 L type stainless steel bracket Code: LW-LMB	 Bridge base Code: LW-AB50	 ALU Reflector Code: RF (optional)	 Aluminum diffuser Code: D050-AD (optional)
 Joiner 90°A Code: J-90A (optional)	 Joiner 120°A Code: J-120A (optional)	 Joiner 180°A Code: J-180A (optional)	

### LW-TR60

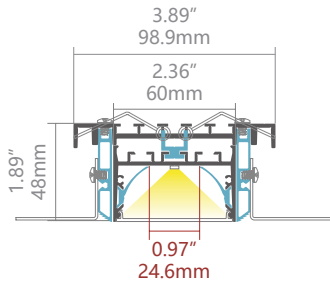
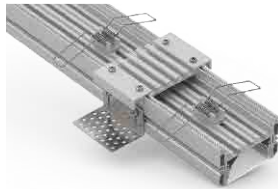

#### PMMA diffuser

- Code: D060-O (Opal, light trans. > 65%)
- Code: D060-N (New opal, light trans. > 74%)

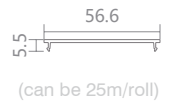

#### PC MICRO PRISM Diffuser

- Code: D060-MP (Micro prism, trans. > 65%)

#### Accessories

 Aluminium endcap Code: E60-CAP	 Aluminium endcap Code: TR60-CAP	 Spring clip Code: SC-WN31	 Trimless bar Code: LW-TR1
 L type stainless steel bracket Code: LW-LMB	 Bridge base Code: LW-AB60	 ALU Reflector Code: RF	 Aluminum diffuser Code: D060-AD (optional)
 Joiner 90°A Code: J-90A (optional)	 Joiner 120°A Code: J-120A (optional)	 Joiner 180°A Code: J-180A (optional)	

### LW-TR80

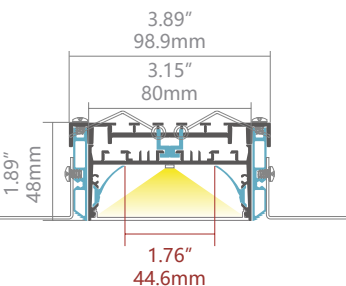

#### PMMA diffuser

- Code: D080-O (Opal, light trans. > 61%)
- Code: D080-N (New opal, light trans. > 74%)

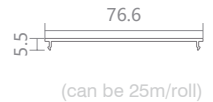

#### Accessories

 Aluminium endcap Code: E80-CAP	 Aluminium endcap Code: TR80-CAP	 Spring clip Code: SC-WN31	 Trimless bar Code: LW-TR1
 L type stainless steel bracket Code: LW-LMB	 Bridge base Code: LW-AB80	 ALU Reflector Code: RF	 Aluminum diffuser Code: D080-AD (optional)
 Joiner 90°A Code: J-90A (optional)	 Joiner 120°A Code: J-120A (optional)	 Joiner 180°A Code: J-180A (optional)	



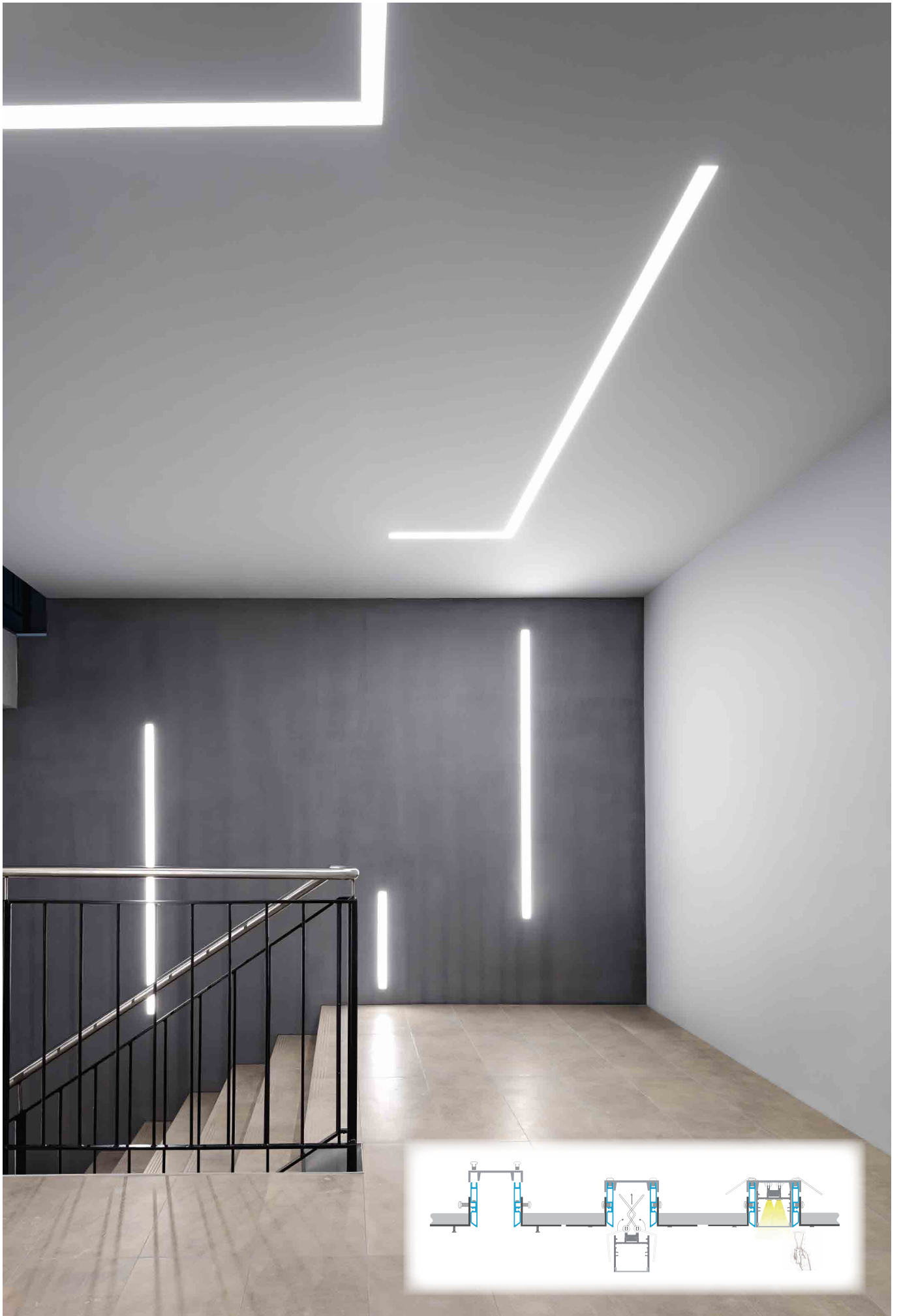

# SURFACE & SUSPENDED -ARCHITECTURAL

Page 56 - 61

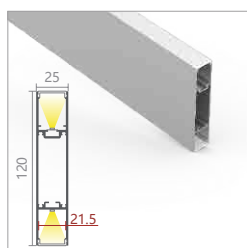
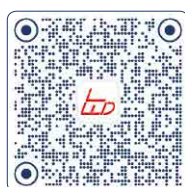

LW-P24

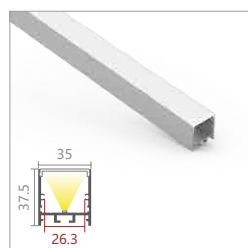

LW-WN35

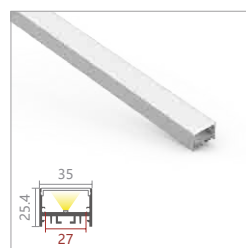

LW-WN35-25

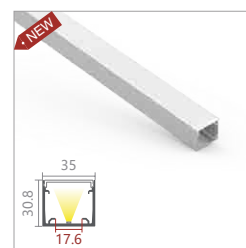

LW-WN35-30

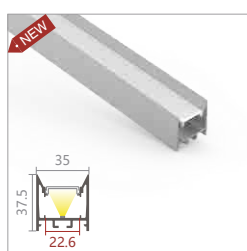

LW-WS35

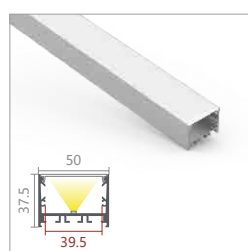

LW-E50

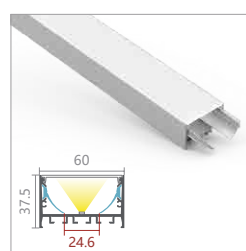

LW-E60

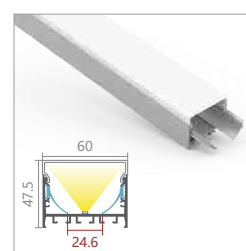

LW-EU60

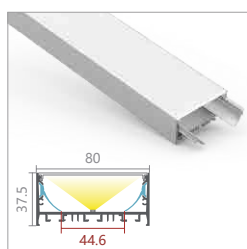

LW-E80

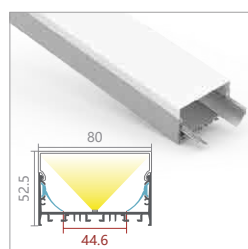

LW-EU80

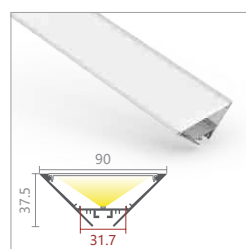

LW-W91

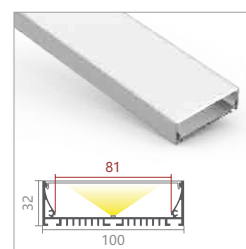

LW-E100

### LW-P24

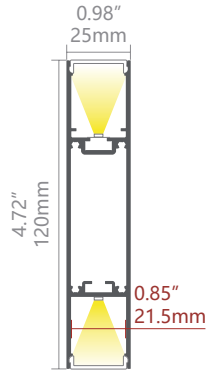

### PMMA Diffuser

Code: P24-N (New opal, light trans. > 65%)



(can be 25m/roll)

### Accessories

**CNC Aluminium endcap**  
Code: P24-CAP-N

**Suspension kits**  
Code: Sus.KitsA

**Wall clip**  
Code: WCLIP (optional)

**Joiner 90°A**  
Code: J-90A (optional)

**Joiner 120°A**  
Code: J-120A (optional)

**Joiner 180°A**  
Code: J-180A (optional)

### LW-WN35

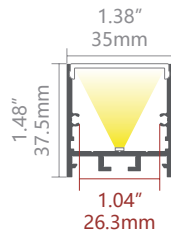

### PMMA Diffuser

Code: D005-O (Opal, light trans. > 63%)  
Code: D005-N (New opal, light trans. > 74%)  
Code: D005-F (Frost, light trans. > 89%)  
Code: D005-C (Clear, light trans. > 95%)  
Code: D005-B (Black, light trans. > 20%)

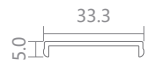

(can be 25m/roll)

### PC MICRO PRISM Diffuser

Code: D005-MP (Micro prism, trans. > 66%)

### Accessories

**CNC Aluminium endcap**  
Code: WN35-CAP-N

**Suspension kits**  
Code: Sus.KitsA

**Aluminum diffuser**  
Code: D005-AD (optional)

**Metal clip**  
Code: WN35-CLIP-M (optional)

**Wall clip**  
Code: WCLIP (optional)

**Joiner 90°A**  
Code: J-90A (optional)

**Joiner 120°A**  
Code: J-120A (optional)

**Joiner 180°A**  
Code: J-180A (optional)

### LW-WN35-25

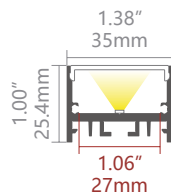

### PMMA Diffuser

Code: D005-O (Opal, light trans. > 63%)  
Code: D005-N (New opal, light trans. > 74%)  
Code: D005-F (Frost, light trans. > 89%)  
Code: D005-C (Clear, light trans. > 95%)  
Code: D005-B (Black, light trans. > 20%)

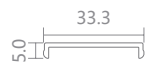

(can be 25m/roll)

### PC MICRO PRISM Diffuser

Code: D005-MP (Micro prism, trans. > 66%)

### Accessories

**Aluminum endcap**  
Code: WN35-25-CAP

**Suspension kits**  
Code: Sus.KitsA

**Aluminum diffuser**  
Code: D005-AD (optional)

**Metal clip**  
Code: WN35-CLIP-M (optional)

**Joiner 90°A**  
Code: J-90A (optional)

**Joiner 120°A**  
Code: J-120A (optional)

**Joiner 180°A**  
Code: J-180A (optional)

**LW-WN35-30** NEW

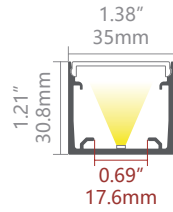

**PMMA Diffuser**

- Code: D005-O (Opal, light trans. > 63%)
- Code: D005-N (New opal, light trans. > 74%)
- Code: D005-F (Frost, light trans. > 89%)
- Code: D005-C (Clear, light trans. > 95%)
- Code: D005-B (Black, light trans. > 20%)

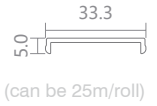

**PC MICRO PRISM Diffuser**

- Code: D005-MP (Micro prism, trans. > 66%)

**Accessories**

<b>CNC Aluminium endcap</b> Code: WN35-30-CAP-N	<b>Suspension kits</b> Code: Sus.Kit	<b>Aluminum diffuser</b> Code: D005-AD (optional)	<b>Suspension Rods</b> Code: Sus.RodsA (optional)
<b>Joiner 90°A</b> Code: J-90A (optional)	<b>Joiner 120°A</b> Code: J-120A (optional)	<b>Joiner 180°A</b> Code: J-180A (optional)	<b>Joiner 180°B</b> Code: J-180B (optional)

**LW-WS35** NEW

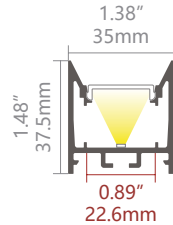

**PMMA Diffuser**

- Code: P24-N (New opal, light trans. > 65%)

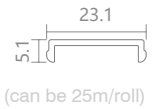

**Accessories**

<b>CNC Aluminium endcap</b> Code: WN35-30-CAP-N	<b>Suspension kits</b> Code: Sus.KitsA	<b>Metal clip</b> Code: WN35-CLIP-M (optional)	<b>Wall clip</b> Code: WCLIP (optional)
<b>Joiner 90°B</b> Code: J-90B (optional)	<b>Joiner 120°B</b> Code: J-120B (optional)	<b>Joiner 180°B</b> Code: J-180B (optional)	

**LW-E50**

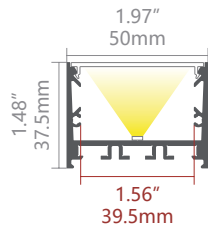

**PMMA diffuser**

- Code: D050-O (Opal, light trans. > 68%)
- Code: D050-N (New opal, light trans. > 74%)
- Code: D050-B (Black, light trans. > 22%)

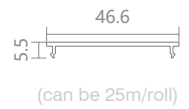

**PC MICRO PRISM Diffuser**

- Code: D050-MP (Micro prism, trans. > 62%)

**Accessories**

<b>CNC Aluminium endcap</b> Code: E50-CAP-N	<b>Suspension kits</b> Code: Sus.KitsA	<b>ALU Reflector</b> Code: RF (optional)	<b>Aluminum diffuser</b> Code: D050-AD (optional)
<b>Aluminium endcap</b> Code: E50-CAP (optional)	<b>Metal clip</b> Code: MC-E50 (optional)	<b>Wall clip</b> Code: WCLIP (optional)	<b>L type stainless steel bracket</b> Code: LW-LMB (optional)
<b>Joiner 90°A</b> Code: J-90A (optional)	<b>Joiner 120°A</b> Code: J-120A (optional)	<b>Joiner 180°A</b> Code: J-180A (optional)	

### LW-E60

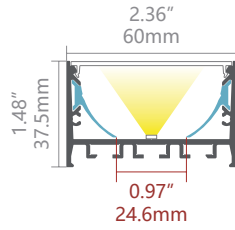

#### PMMA diffuser

Code: D060-O (Opal, light trans. > 65%)  
 Code: D060-N (New opal, light trans. > 74%)













#### PC MICRO PRISM Diffuser

Code: D060-MP (Micro prism, trans. > 65%)

(can be 25m/roll)

#### Accessories

 <b>CNC Aluminium endcap</b> Code: E60-CAP-N	 <b>ALU Reflector</b> Code: RF	 <b>Suspension kits</b> Code: Sus.KitsA	 <b>Aluminum diffuser</b> Code: D060-AD (optional)
 <b>Aluminium endcap</b> Code: E60-CAP (optional)	 <b>Metal clip</b> Code: MC-E50 (optional)	 <b>Wall clip</b> Code: WCLIP (optional)	 <b>L type stainless steel bracket</b> Code: LW-LMB (optional)
 <b>Joiner 90°A</b> Code: J-90A (optional)	 <b>Joiner 120°A</b> Code: J-120A (optional)	 <b>Joiner 180°A</b> Code: J-180A (optional)	

### LW-EU60

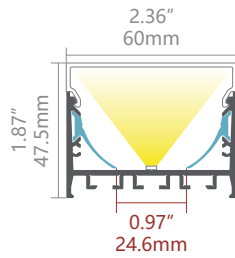
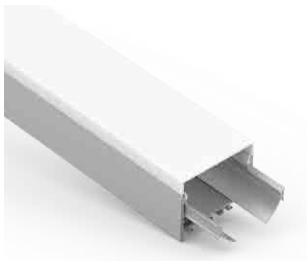





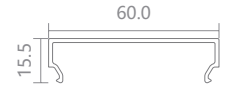



#### PMMA diffuser

Code: D060U-O (Opal, light trans. > 54%)



#### Accessories

 <b>Aluminium endcap</b> Code: EU60-CAP	 <b>ALU Reflector</b> Code: RF	 <b>Suspension kits</b> Code: Sus.KitsA	 <b>Metal clip</b> Code: MC-E50 (optional)
 <b>Wall clip</b> Code: WCLIP (optional)	 <b>Joiner 90°A</b> Code: J-90A (optional)	 <b>Joiner 120°A</b> Code: J-120A (optional)	 <b>Joiner 180°A</b> Code: J-180A (optional)

### LW-E80

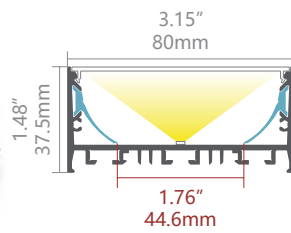

#### PMMA diffuser

Code: D080-O (Opal, light trans. > 61%)  
 Code: D080-N (New opal, light trans. > 74%)



(can be 25m/roll)

#### Accessories

 <b>CNC Aluminium endcap</b> Code: E80-CAP-N	 <b>ALU Reflector</b> Code: RF	 <b>Suspension kits</b> Code: Sus.KitsA	 <b>Aluminum diffuser</b> Code: D080-AD (optional)
 <b>Aluminium endcap</b> Code: E80-CAP (optional)	 <b>Metal clip</b> Code: MC-E50 (optional)	 <b>Wall clip</b> Code: WCLIP (optional)	 <b>L type stainless steel bracket</b> Code: LW-LMB (optional)
 <b>Joiner 90°A</b> Code: J-90A (optional)	 <b>Joiner 120°A</b> Code: J-120A (optional)	 <b>Joiner 180°A</b> Code: J-180A (optional)	

**LW-EU80**

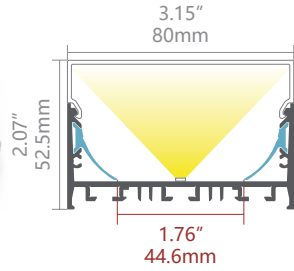

**PMMA Diffuser**

Code: D080U-O (Opal, light trans. > 43%)



**Accessories**



**Aluminium endcap**  
Code: EU80-CAP



**ALU Reflector**  
Code: RF



**Suspension kits**  
Code: Sus.KitsA



**CNC Aluminium endcap**  
Code: EU80-CAP-N (optional)



**Metal clip**  
Code: MC-E50 (optional)



**Wall clip**  
Code: WCLIP (optional)



**Joiner 90°A**  
Code: J-90A (optional)



**Joiner 120°A**  
Code: J-120A (optional)



**Joiner 180°A**  
Code: J-180A (optional)

**LW-W91**

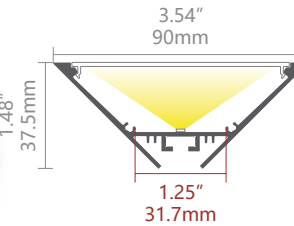

**PMMA diffuser**

Code: D080-O (Opal, light trans. > 61%)  
Code: D080-N (New opal, light trans. > 74%)

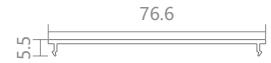

(can be 25m/roll)

**Accessories**



**Aluminium endcap**  
Code: W91-CAP



**Suspension kits**  
Code: Sus.KitsA



**Aluminum diffuser**  
Code: D080-AD (optional)



**Joiner 90°A**  
Code: J-90A (optional)



**Joiner 120°A**  
Code: J-120A (optional)



**Joiner 180°A**  
Code: J-180A (optional)

**LW-E100**

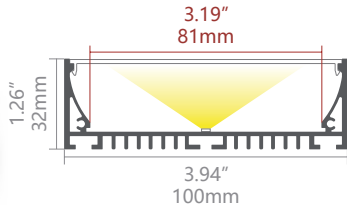

**PC diffuser**

Code: E100-O (Opal, light trans. > 72%)

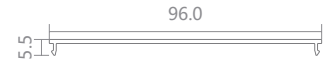

**Accessories**



**Aluminium endcap**  
Code: E100-CAP



**Suspension kits**  
Code: Sus.KitsA



**Wall clip**  
Code: WCLIP (optional)



**Joiner 90°A**  
Code: J-90A (optional)



**Joiner 120°A**  
Code: J-120A (optional)



**Joiner 180°A**  
Code: J-180A (optional)

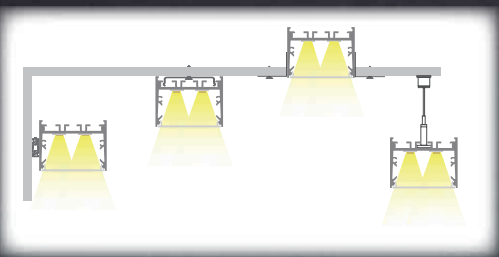
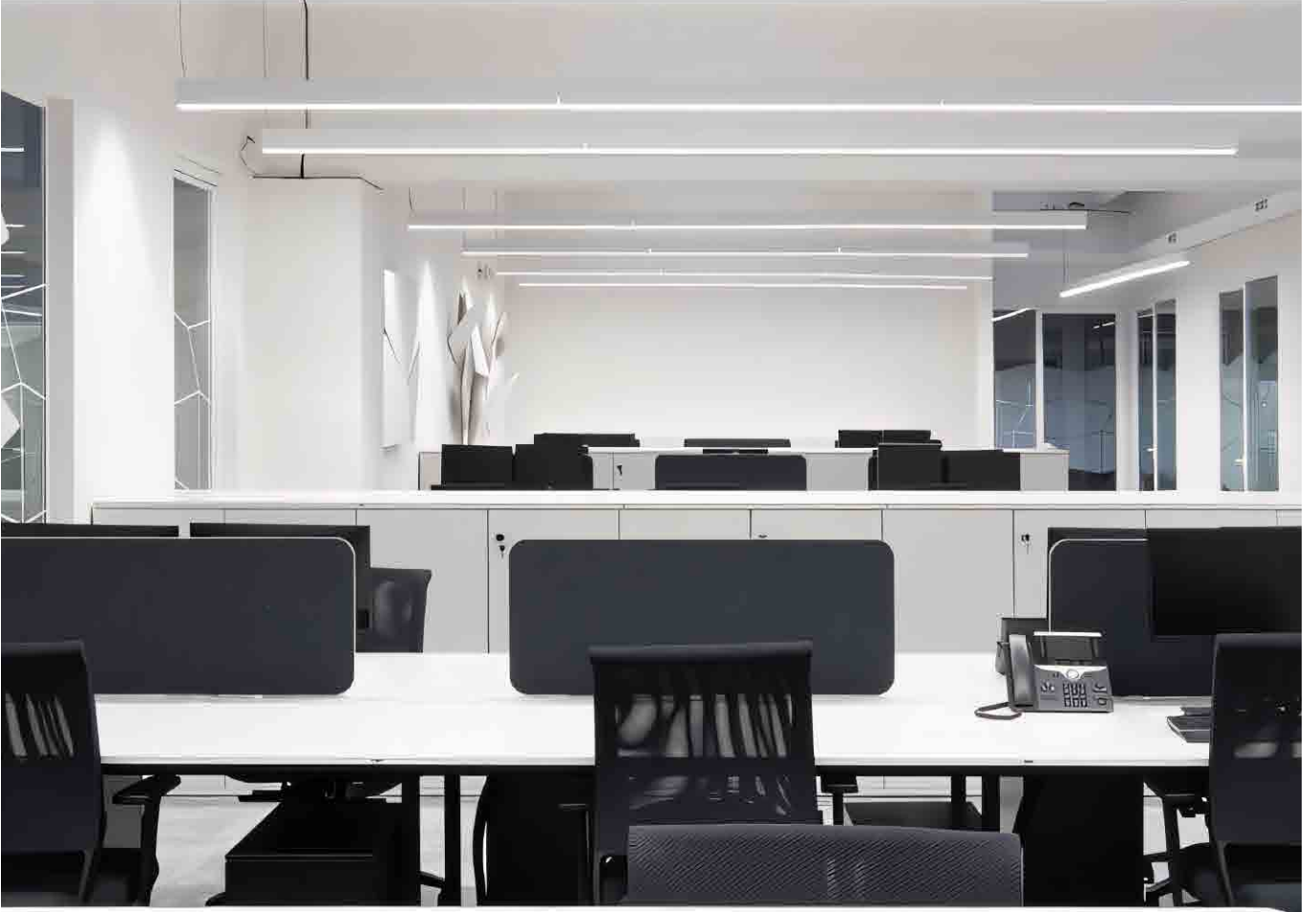

# RECESSED- ARCHITECTURAL

Page 62 - 65

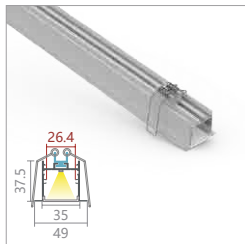
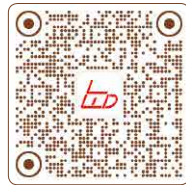

LW-WN31

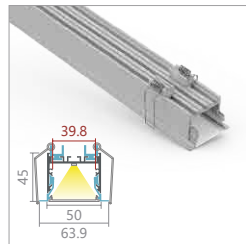

LW-ER50

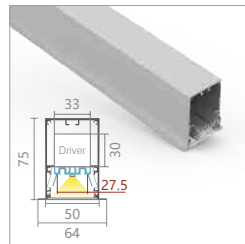

LW-PR50N

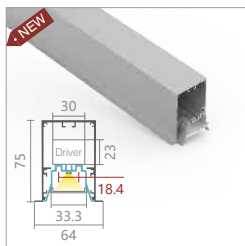

LW-PR50N-S

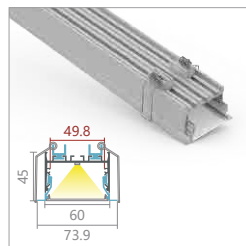

LW-ER60

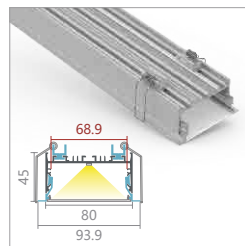

LW-ER80



### LW-WN31

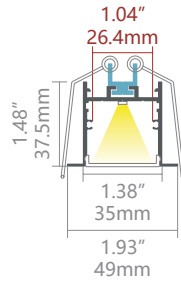

### PMMA Diffuser

- Code: D005-O (Opal, light trans. > 63%)
- Code: D005-N (New opal, light trans. > 74%)
- Code: D005-F (Frost, light trans. > 89%)
- Code: D005-C (Clear, light trans. > 95%)
- Code: D005-B (Black, light trans. > 20%)

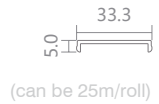

### PC MICRO PRISM Diffuser

- Code: D005-MP (Micro prism, trans. > 66%)

### Accessories

<b>Aluminium endcap</b> Code: WN31-CAP Code: WN31-CAP-H	<b>Spring clip</b> Code: SC-WN31	<b>Aluminum diffuser</b> Code: D005-AD (optional)	<b>Metal clip</b> Code: MC-WS31 (optional)
<b>Joiner 90°A</b> Code: J-90A (optional)	<b>Joiner 120°A</b> Code: J-120A (optional)	<b>Joiner 180°A</b> Code: J-180A (optional)	

### LW-ER50

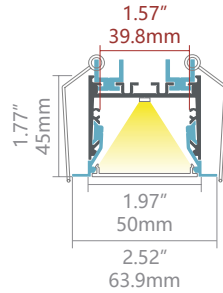
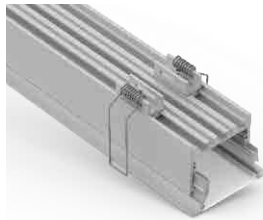

### PMMA diffuser

- Code: D050-O (Opal, light trans. > 68%)
- Code: D050-N (New opal, light trans. > 74%)
- Code: D050-B (Black, light trans. > 22%)

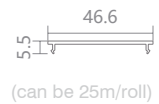

### PC MICRO PRISM Diffuser

- Code: D050-MP (Micro prism, trans. > 62%)

### Accessories

<b>Aluminium endcap</b> Code: ER50-CAP Code: ER50-CAP-H	<b>Spring clip</b> Code: SC-ER	<b>Aluminum diffuser</b> Code: D050-AD (optional)	<b>Joiner 90°A</b> Code: J-90A (optional)
<b>Joiner 120°A</b> Code: J-120A (optional)	<b>Joiner 180°A</b> Code: J-180A (optional)		

### LW-PR50N

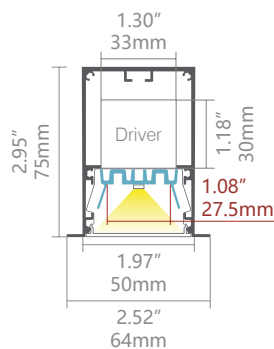
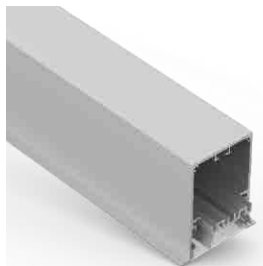

### PMMA diffuser

- Code: D050-O (Opal, light trans. > 68%)
- Code: D050-N (New opal, light trans. > 74%)
- Code: D050-B (Black, light trans. > 22%)

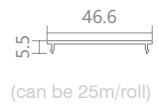

### PC MICRO PRISM Diffuser

- Code: D050-MP (Micro prism, trans. > 62%)

### Accessories

<b>CNC Aluminium endcap</b> Code: PR50N-CAP-N	<b>Gear tray clip</b> Code: P50N-CLIP-GEAR TRAY	<b>Aluminum U clip</b> Code: P50N-CLIP	<b>Aluminum diffuser</b> Code: D050-AD (optional)
<b>Joiner 90°A</b> Code: J-90A (optional)	<b>Joiner 90°B</b> Code: J-90B (optional)	<b>Joiner 120°A</b> Code: J-120A (optional)	<b>Joiner 120°B</b> Code: J-120B (optional)
<b>Joiner 180°A</b> Code: J-180A (optional)	<b>Joiner 180°B</b> Code: J-180B (optional)		

**LW-PR50N-S** NEW

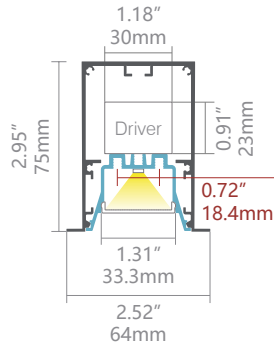

**PMMA Diffuser**

- Code: D005-O (Opal, light trans. > 63%)
- Code: D005-N (New opal, light trans. > 74%)
- Code: D005-F (Frost, light trans. > 89%)
- Code: D005-C (Clear, light trans. > 95%)
- Code: D005-B (Black, light trans. > 20%)

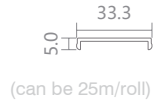

**PC MICRO PRISM Diffuser**

- Code: D005-MP (Micro prism, trans. > 66%)

**Accessories**

<b>CNC Aluminium endcap</b> Code: PR50N-CAP-N	<b>Gear tray clip</b> Code: P50N-CLIP-GEAR TRAY	<b>Aluminum U clip</b> Code: P50N-CLIP	<b>Aluminum diffuser</b> Code: D050-AD (optional)
<b>Joiner 90°A</b> Code: J-90A (optional)	<b>Joiner 90°B</b> Code: J-90B (optional)	<b>Joiner 120°A</b> Code: J-120A (optional)	<b>Joiner 120°B</b> Code: J-120B (optional)
<b>Joiner 180°A</b> Code: J-180A (optional)	<b>Joiner 180°B</b> Code: J-180B (optional)		

**LW-ER60**

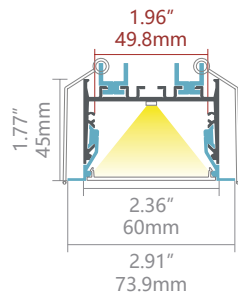
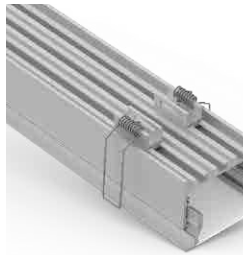

**PMMA diffuser**

- Code: D060-O (Opal, light trans. > 65%)
- Code: D060-N (New opal, light trans. > 74%)

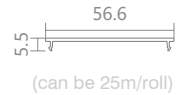

**PC MICRO PRISM Diffuser**

- Code: D060-MP (Micro prism, trans. > 65%)

**Accessories**

<b>Aluminium endcap</b> Code: ER60-CAP Code: ER60-CAP-H	<b>Spring clip</b> Code: SC-ER	<b>Aluminum diffuser</b> Code: D060-AD (optional)
<b>Joiner 90°A</b> Code: J-90A (optional)	<b>Joiner 120°A</b> Code: J-120A (optional)	<b>Joiner 180°A</b> Code: J-180A (optional)

**LW-ER80**

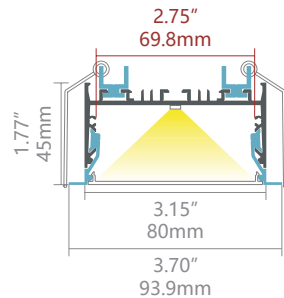

**PMMA diffuser**

- Code: D080-O (Opal, light trans. > 61%)
- Code: D080-N (New opal, light trans. > 74%)

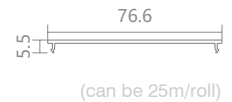

**Accessories**

<b>Aluminium endcap</b> Code: ER80-CAP Code: ER80-CAP-H	<b>Spring clip</b> Code: SC-ER	<b>Aluminum diffuser</b> Code: D080-AD (optional)
<b>Joiner 90°A</b> Code: J-90A (optional)	<b>Joiner 120°A</b> Code: J-120A (optional)	<b>Joiner 180°A</b> Code: J-180A (optional)

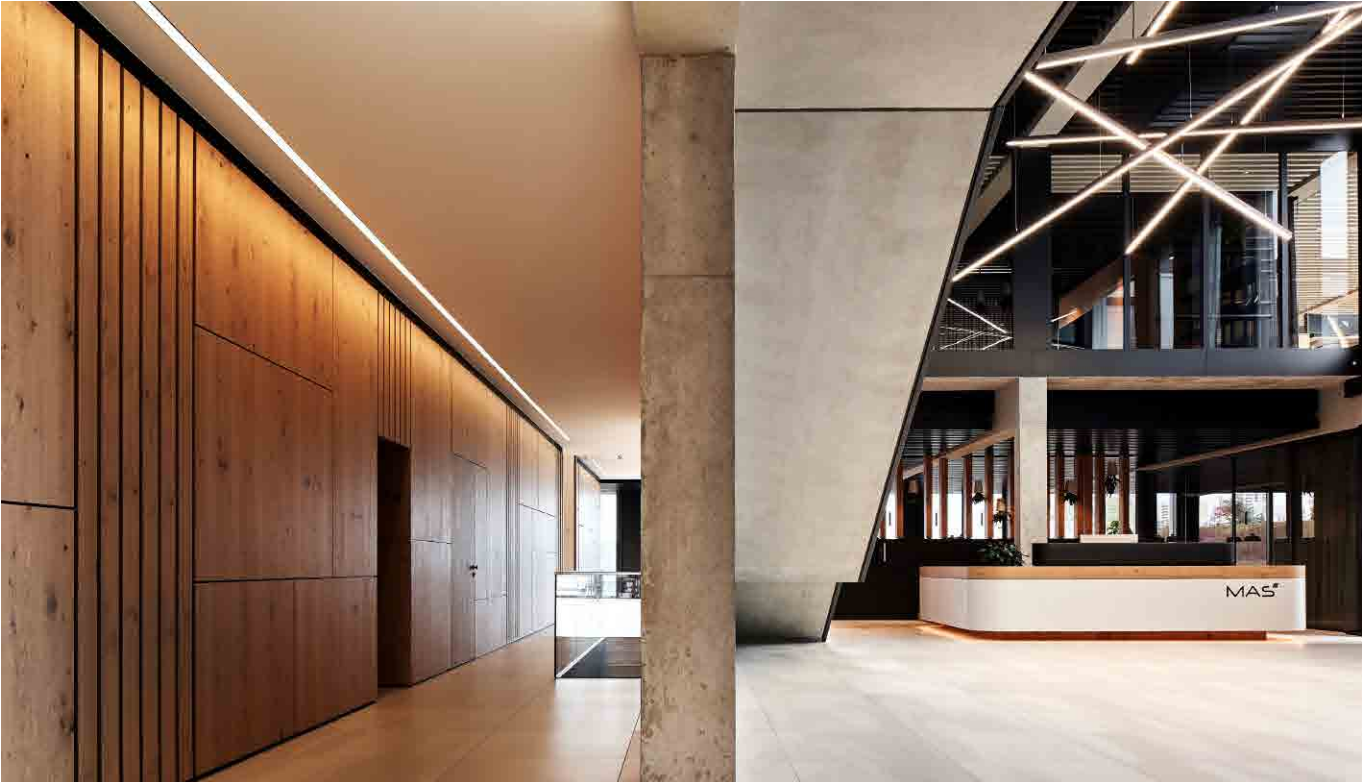

# PLASTER-IN

Page 66 - 70

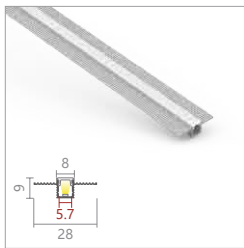
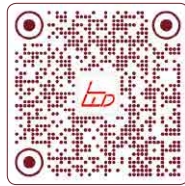

LW-CT9

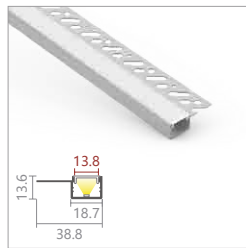

LW-CT5S

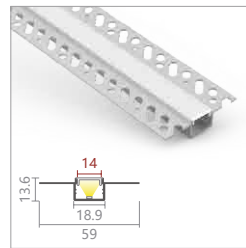

LW-CT5

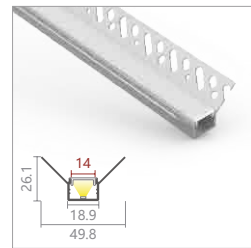

LW-CT6

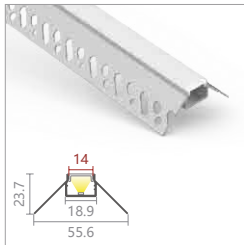

LW-CT7

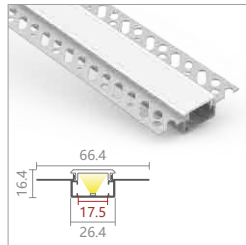

LW-CT4N

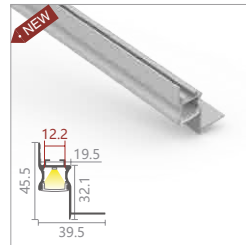

LW-AT7N-1

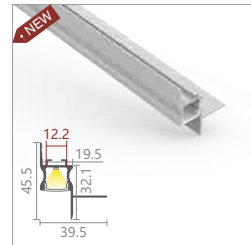

LW-AT10

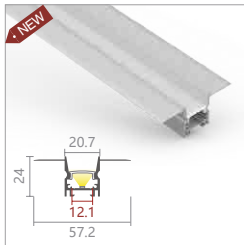

LW-CTD1

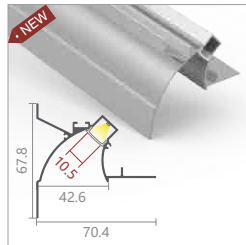

LW-CTV1

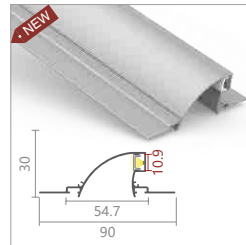

LW-CTV2

### LW-CT9

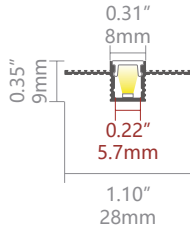

### PC Diffuser

Code: AS9-O (Opal, light trans. > 45%)



### PMMA Diffuser

Code: AS9-B (Black, light trans. > 24%)

(can be 25m/roll)

### Accessories



### Plastic endcap

Code: CT9-CAP  
Code: CT9-CAP-H

### LW-CT5S

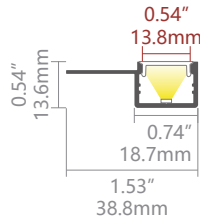

### PMMA Diffuser

Code: D001-O FLAT (Opal, light trans. > 68%)



(can be 25m/roll)

### Accessories



### Plastic endcap

Code: CT5-CAP  
Code: CT5-CAP-H

### LW-CT5

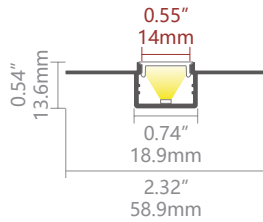

### PMMA Diffuser

Code: D001-O FLAT (Opal, light trans. > 68%)



(can be 25m/roll)

### Accessories



### Plastic endcap

Code: CT5-CAP  
Code: CT5-CAP-H

### LW-CT6

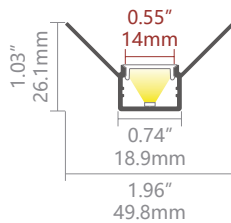

### PMMA Diffuser

Code: D001-O FLAT (Opal, light trans. > 68%)



(can be 25m/roll)

### Accessories



### Plastic endcap

Code: CT5-CAP  
Code: CT5-CAP-H

### LW-CT7

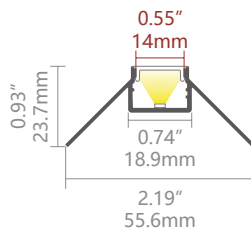

### PMMA Diffuser

Code: D001-O FLAT (Opal, light trans. > 68%)



(can be 25m/roll)

### Accessories



### Plastic endcap

Code: CT5-CAP  
Code: CT5-CAP-H

**LW-CT4N**

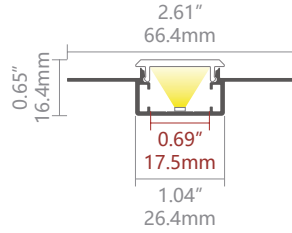

**PC Diffuser**

Code: CT4N-O (Opal, light trans. > 51%)  
Code: CT4N-N (New opal, light trans. > 66%)

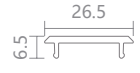

(can be 25m/roll)

**Accessories**

**Plastic endcap**  
Code: CT4N-CAP  
Code: CT4N-CAP-H

**Joiner 60°B**  
Code: J-60B  
(optional)

**Joiner 90°B**  
Code: J-90B  
(optional)

**Joiner 120°B**  
Code: J-120B  
(optional)

**Joiner 180°A**  
Code: J-180A  
(optional)

**LW-AT7N-1**

**NEW**

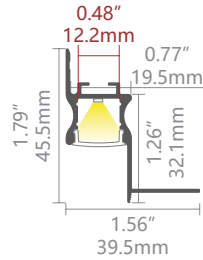

**PMMA Diffuser**

Code: D001-O (Opal, light trans. > 58%)  
Code: D001-M (Milky, light trans. > 75%)  
Code: D001-F (Frost, light trans. > 88%)  
Code: D001-C (Clear, light trans. > 97%)  
Code: D001-B (Black, light trans. > 21%)

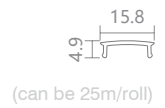

(can be 25m/roll)

**Accessories**

**Plastic endcap**  
Code: AS2-CAP  
Code: AS2-CAP-H

**Joiner 90°A**  
Code: J-90A  
(optional)

**Joiner 90°B**  
Code: J-90B  
(optional)

**Joiner 180°A**  
Code: J-180A  
(optional)

**LW-AT10**

**NEW**

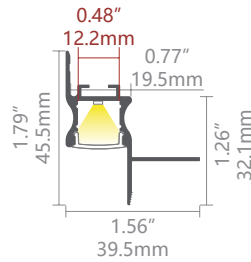

**PMMA Diffuser**

Code: D001-O (Opal, light trans. > 58%)  
Code: D001-M (Milky, light trans. > 75%)  
Code: D001-F (Frost, light trans. > 88%)  
Code: D001-C (Clear, light trans. > 97%)  
Code: D001-B (Black, light trans. > 21%)

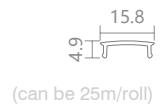

(can be 25m/roll)

**Accessories**

**Plastic endcap**  
Code: AS2-CAP  
Code: AS2-CAP-H

**Joiner 90°A**  
Code: J-90A  
(optional)

**Joiner 90°B**  
Code: J-90B  
(optional)

**Joiner 180°A**  
Code: J-180A  
(optional)

**LW-CTD1**

**NEW**

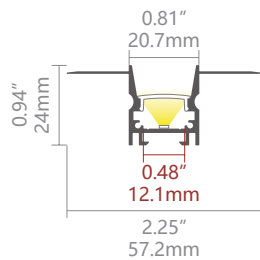
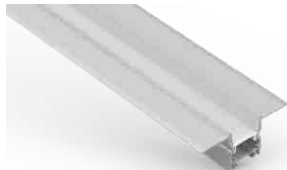

**PMMA Diffuser**

Code: D001-O (Opal, light trans. > 58%)  
Code: D001-M (Milky, light trans. > 75%)  
Code: D001-F (Frost, light trans. > 88%)  
Code: D001-C (Clear, light trans. > 97%)  
Code: D001-B (Black, light trans. > 21%)

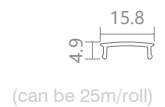

(can be 25m/roll)

**Accessories**

**Aluminium endcap**  
Code: CTD1-CAP  
Code: CTD1-CAP-H

**Joiner 180°A**  
Code: J-180A  
(optional)

**LW-CTV1** NEW

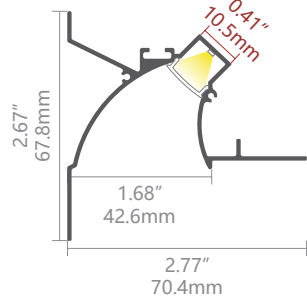

**PMMA Diffuser**

Code: CTV1-O (Opal, light trans. > 50%)

**Accessories**



**Aluminium endcap**

Code: CTV1-CAP



**Joiner 90°A**

Code: J-90A  
(optional)



**Joiner 120°A**

Code: J-120A  
(optional)



**Joiner 180°A**

Code: J-180A  
(optional)



**LW-CTV2** NEW

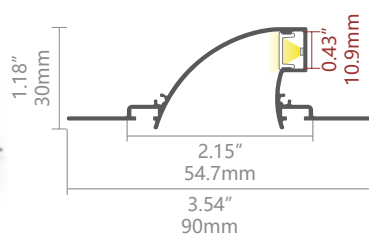

**PMMA Diffuser**

Code: CTV1-O (Opal, light trans. > 50%)

**Accessories**



**Aluminium endcap**

Code: CTV2-CAP



**Joiner 90°A**

Code: J-90A  
(optional)



**Joiner 120°A**

Code: J-120A  
(optional)



**Joiner 180°A**

Code: J-180A  
(optional)



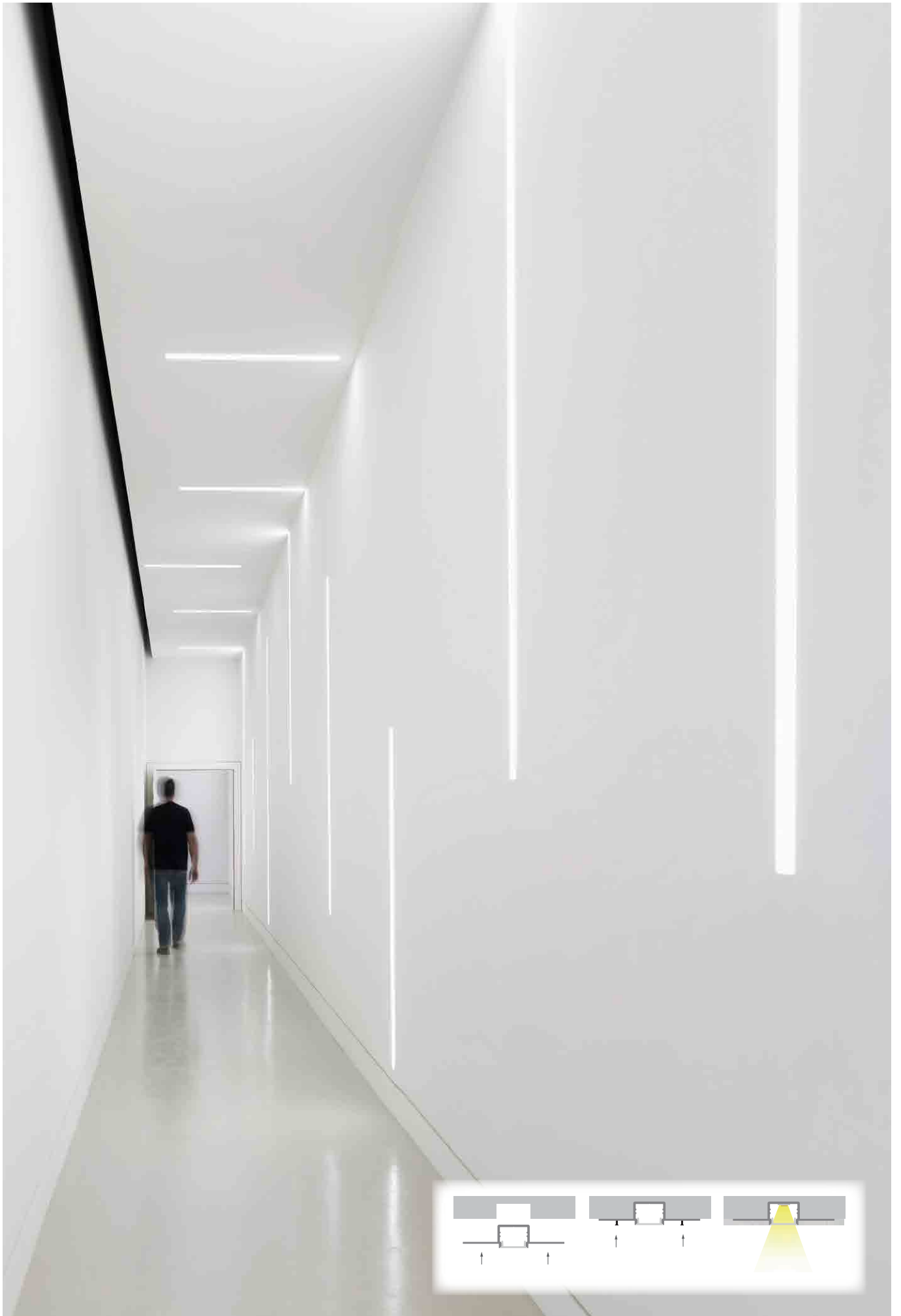



# COVE FRAME SYSTEM

Page 71 - 72

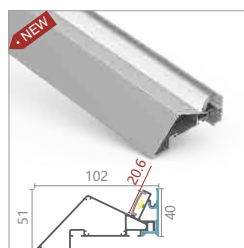
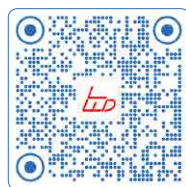

LW-KN1

**LW-KN1** NEW

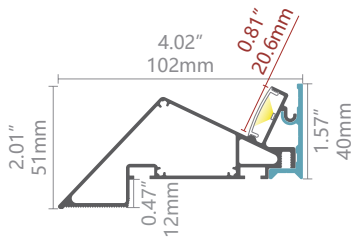



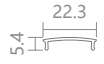

**PMMA Diffuser**

- Code: D003-O (Opal, light trans. > 70%)
- Code: D003-M (Milky, light trans. > 78%)
- Code: D003-F (Frost, light trans. > 91%)
- Code: D003-C (Clear, light trans. > 94%)



(can be 25m/roll)

**Accessories**

- |   |   |  |  |
|---|---|--|--|
| <br><b>Aluminum endcap</b><br>Code: KN1-CAP-N          | <br><b>Joiner 90°A</b><br>Code: J-90A<br>(optional)      | <br><b>Joiner 120°A</b><br>Code: J-120A<br>(optional) | <br><b>Joiner 180°A</b><br>Code: J-180A<br>(optional) |
| <br><b>Inside Corner</b><br>Code: IN-90D<br>(optional) | <br><b>Outside Corner</b><br>Code: OUT-90D<br>(optional) | <b>Customized Corners</b><br>(optional)  |  |





## LEDWIDE LIGHTING CO., LTD

<b>Address</b>	1-2/F, Building A2, Sinopol Ind.Park, First Industrial Zone, BaiHua communities, Guangming District,Shenzhen, P.R. China
<b>Postcode</b>	518107
<b>Tel</b>	86 755 29362351
<b>Mobile</b>	0086-018680360436 (Wechat/Whatsapp)
<b>Contact</b>	Ms Lily Liu (sales manager)
<b>Email</b>	info@ledwide.com